

THULE WingBar Evo	THULE WingBar Edge	THULE WingBar	THULE SquareBar Evo	<b>Evo X (scale)</b>	<b>Edge X (scale)</b>
<b>TOYOTA Prius, 5-dr Hatchback, 09-15 / *10-15</b>				<b>40</b>	<b>Q</b>
THULE ProBar Evo	THULE SlideBar Evo				<b>X (mm/inch)</b>
<b>TOYOTA Prius, 5-dr Hatchback, 09-15 / *10-15</b>				<b>1051 mm / 41 3/8"</b>	

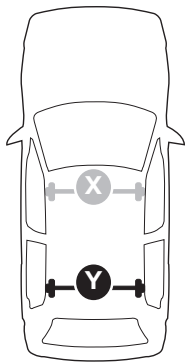

THULE WingBar Evo	THULE WingBar Edge	THULE WingBar	THULE SquareBar Evo	<b>Evo Y (scale)</b>	<b>Edge Y (scale)</b>
<b>TOYOTA Prius, 5-dr Hatchback, 09-15 / *10-15</b>				<b>35,5</b>	<b>H</b>
THULE ProBar Evo	THULE SlideBar Evo				<b>Y (mm/inch)</b>
<b>TOYOTA Prius, 5-dr Hatchback, 09-15 / *10-15</b>				<b>1006 mm / 39 5/8"</b>	

	<b>W (mm/inch)</b>	<b>Z (mm/inch)</b>
<b>TOYOTA Prius, 5-dr Hatchback, 09-15 / *10-15</b>	<b>720 mm / 27 1/2"</b>	<b>250 mm / 9 7/8"</b>

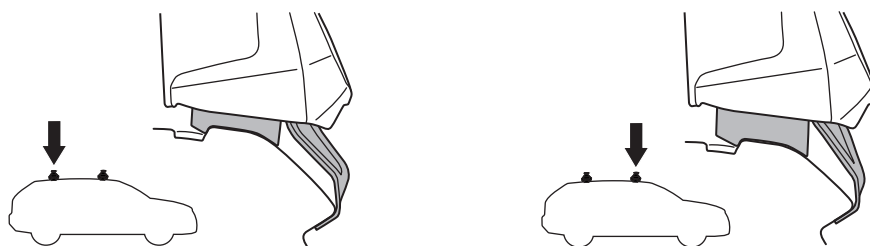
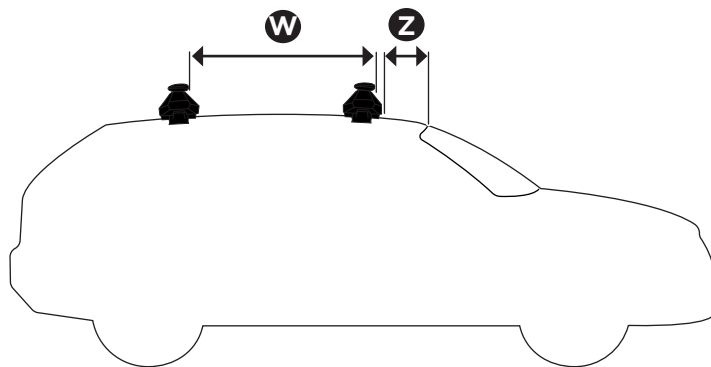

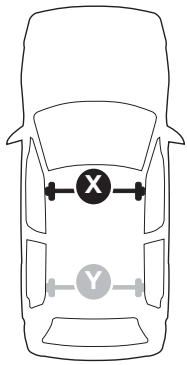

THULE WingBar Evo	THULE WingBar Edge	THULE WingBar	THULE SquareBar Evo	<b>Evo X (scale)</b>	<b>Edge X (scale)</b>
TOYOTA Hilux, 4-dr Double Cab, 16-				40	Q
TOYOTA Hilux, 4-dr Extra Cab, 16-				40	Q

THULE ProBar Evo	THULE SlideBar Evo	<b>X (mm/inch)</b>		
TOYOTA Hilux, 4-dr Double Cab, 16-		1051 mm / 41 3/8"		
TOYOTA Hilux, 4-dr Extra Cab, 16-		1051 mm / 41 3/8"		

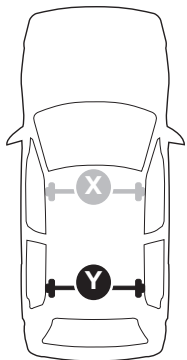

THULE WingBar Evo	THULE WingBar Edge	THULE WingBar	THULE SquareBar Evo	<b>Evo Y (scale)</b>	<b>Edge Y (scale)</b>
TOYOTA Hilux, 4-dr Double Cab, 16-				40	Q
TOYOTA Hilux, 4-dr Extra Cab, 16-				40	Q

THULE ProBar Evo	THULE SlideBar Evo	<b>Y (mm/inch)</b>		
TOYOTA Hilux, 4-dr Double Cab, 16-		1051 mm / 41 3/8"		
TOYOTA Hilux, 4-dr Extra Cab, 16-		1051 mm / 41 3/8"		

	<b>W (mm/inch)</b>	<b>Z (mm/inch)</b>
TOYOTA Hilux, 4-dr Double Cab, 16-	750 mm / 29 1/2"	300 mm / 11 3/4"
TOYOTA Hilux, 4-dr Extra Cab, 16-	700 mm / 27 1/2"	300 mm / 11 3/4"

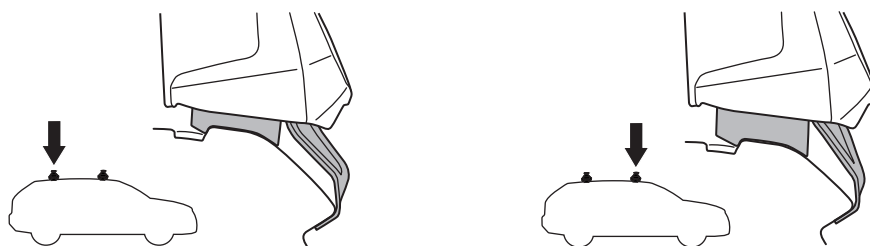
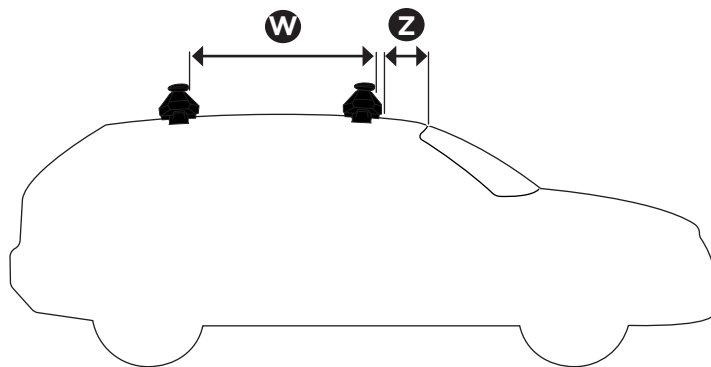

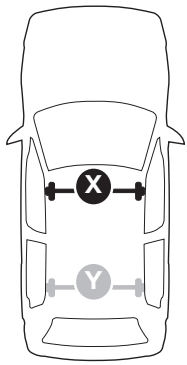

THULE WingBar Evo	THULE WingBar Edge	THULE WingBar	THULE SquareBar Evo	<b>Evo X (scale)</b>	<b>Edge X (scale)</b>
<b>MINI Clubman, 5-dr Hatchback, 16-</b>				<b>32</b>	<b>0</b>
THULE ProBar Evo	THULE SlideBar Evo				<b>X (mm/inch)</b>
<b>MINI Clubman, 5-dr Hatchback, 16-</b>				<b>971 mm / 38 1/4"</b>	

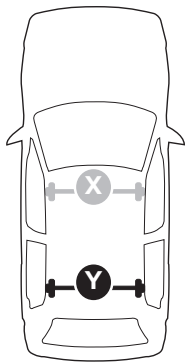

THULE WingBar Evo	THULE WingBar Edge	THULE WingBar	THULE SquareBar Evo	<b>Evo Y (scale)</b>	<b>Edge Y (scale)</b>
<b>MINI Clubman, 5-dr Hatchback, 16-</b>				<b>30,5</b>	<b>R</b>
THULE ProBar Evo	THULE SlideBar Evo				<b>Y (mm/inch)</b>
<b>MINI Clubman, 5-dr Hatchback, 16-</b>				<b>956 mm / 37 5/8"</b>	

	<b>W (mm/inch)</b>	<b>Z (mm/inch)</b>
<b>MINI Clubman, 5-dr Hatchback, 16-</b>	<b>700 mm / 27 1/2"</b>	<b>300 mm / 11 3/4"</b>

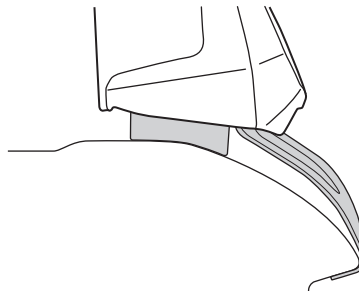
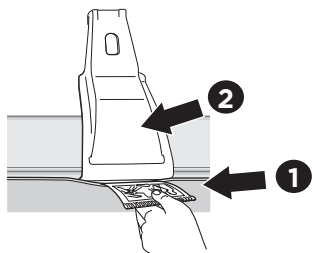
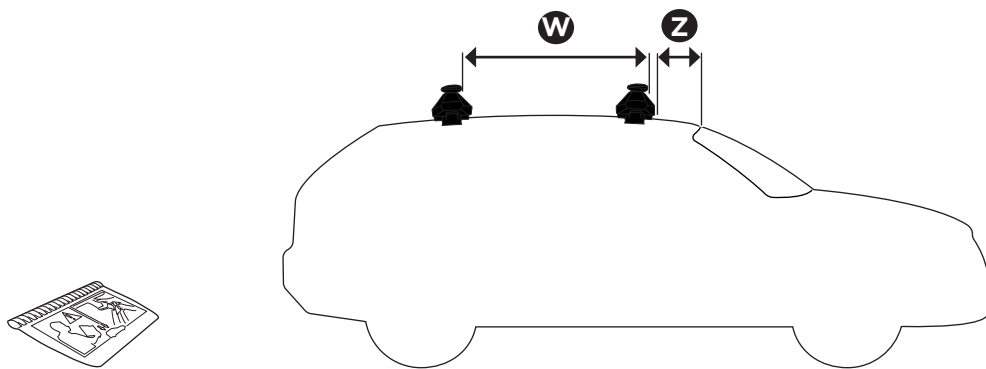

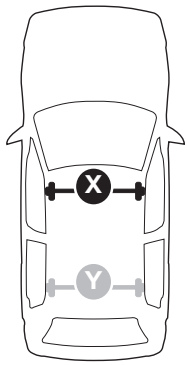

THULE WingBar Evo	THULE WingBar Edge	THULE WingBar	THULE SquareBar Evo	Evo X (scale)	Edge X (scale)
FIAT Grande Punto, 5-dr Hatchback, 05-12				27	G
FIAT Punto Evo, 5-dr Hatchback, 09-12				27	G
FIAT Punto, 5-dr Hatchback, 12-				27	G

THULE ProBar Evo	THULE SlideBar Evo	X (mm/inch)
FIAT Grande Punto, 5-dr Hatchback, 05-12		921 mm / 36 1/4"
FIAT Punto Evo, 5-dr Hatchback, 09-12		921 mm / 36 1/4"
FIAT Punto, 5-dr Hatchback, 12-		921 mm / 36 1/4"

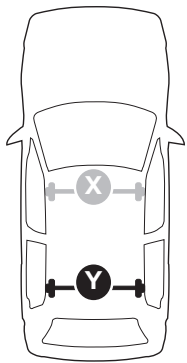

THULE WingBar Evo	THULE WingBar Edge	THULE WingBar	THULE SquareBar Evo	Evo Y (scale)	Edge Y (scale)
FIAT Grande Punto, 5-dr Hatchback, 05-12				21	A
FIAT Punto Evo, 5-dr Hatchback, 09-12				21	A
FIAT Punto, 5-dr Hatchback, 12-				21	A

THULE ProBar Evo	THULE SlideBar Evo	Y (mm/inch)
FIAT Grande Punto, 5-dr Hatchback, 05-12		861 mm / 33 7/8"
FIAT Punto Evo, 5-dr Hatchback, 09-12		861 mm / 33 7/8"
FIAT Punto, 5-dr Hatchback, 12-		861 mm / 33 7/8"

	W (mm/inch)	Z (mm/inch)
FIAT Grande Punto, 5-dr Hatchback, 05-12	800 mm / 31 1/2"	250 mm / 9 7/8"
FIAT Punto Evo, 5-dr Hatchback, 09-12	800 mm / 31 1/2"	250 mm / 9 7/8"
FIAT Punto, 5-dr Hatchback, 12-	800 mm / 31 1/2"	250 mm / 9 7/8"

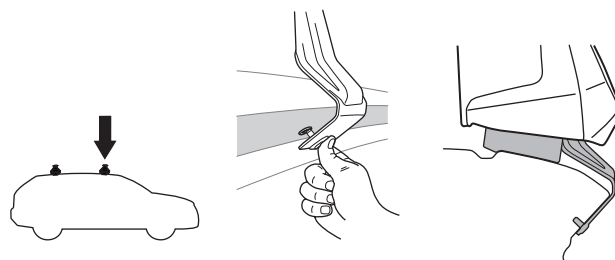
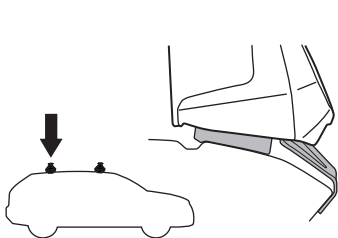
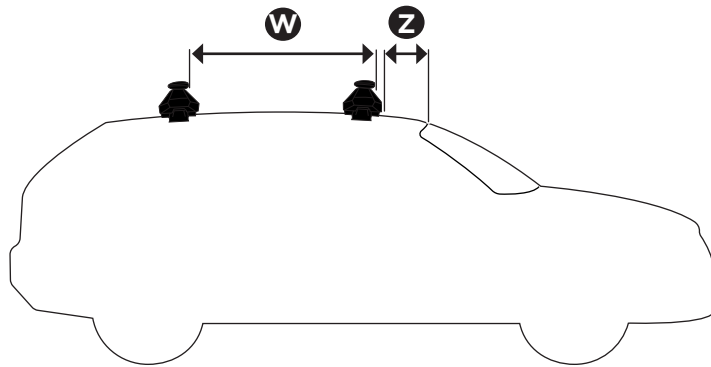

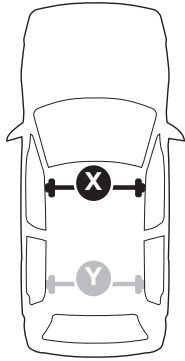

THULE WingBar Evo	THULE WingBar Edge	THULE WingBar	THULE SquareBar Evo	<b>Evo X (scale)</b>	<b>Edge X (scale)</b>
SKODA Octavia, 5-dr Hatchback, 13-				40,5	P
SKODA Octavia, 4-dr Sedan, 13-				40,5	P
THULE ProBar Evo	THULE SlideBar Evo			<b>X (mm/inch)</b>	
SKODA Octavia, 5-dr Hatchback, 13-				1056 / 41 5/8"	
SKODA Octavia, 4-dr Sedan, 13-				1056 / 41 5/8"	

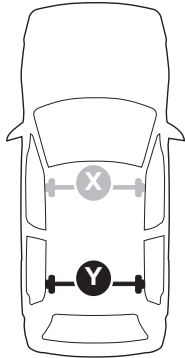

THULE WingBar Evo	THULE WingBar Edge	THULE WingBar	THULE SquareBar Evo	<b>Evo Y (scale)</b>	<b>Edge Y (scale)</b>
SKODA Octavia, 5-dr Hatchback, 13-				37,5	D
SKODA Octavia, 4-dr Sedan, 13-				37,5	D
THULE ProBar Evo	THULE SlideBar Evo			<b>Y (mm/inch)</b>	
SKODA Octavia, 5-dr Hatchback, 13-				1026 / 40 3/8"	
SKODA Octavia, 4-dr Sedan, 13-				1026 / 40 3/8"	

	<b>W (mm/inch)</b>	<b>Z (mm/inch)</b>
SKODA Octavia, 5-dr Hatchback, 13-	700 / 27 1/2"	235 / 9 1/4"
SKODA Octavia, 4-dr Sedan, 13-	700 / 27 1/2"	235 / 9 1/4"

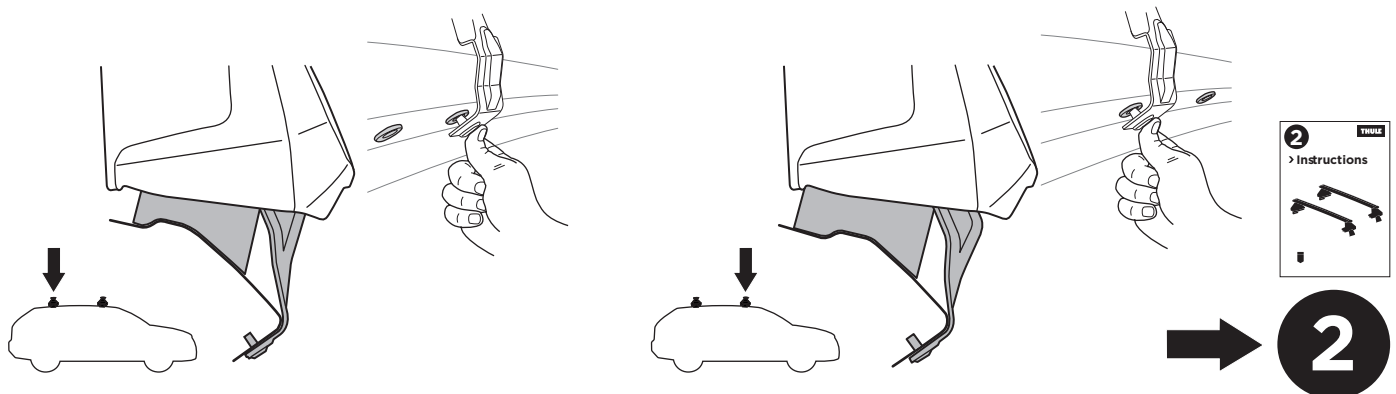
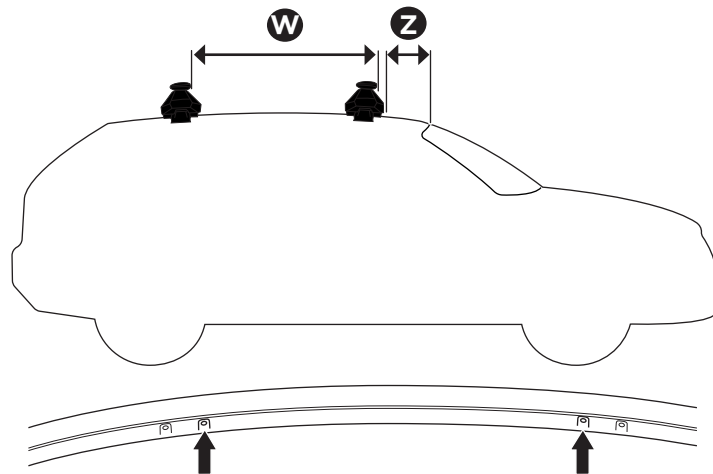

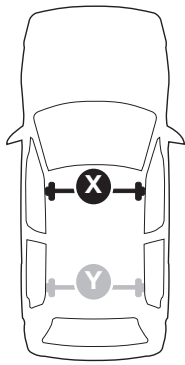

THULE WingBar Evo	THULE WingBar Edge	THULE WingBar	THULE SquareBar Evo	<b>Evo X (scale)</b>	<b>Edge X (scale)</b>
<b>RENAULT Scénic (Mk. IV), 5-dr MPV, 17-</b>				<b>51,5</b>	<b>L</b>
THULE ProBar Evo	THULE SlideBar Evo				<b>X (mm/inch)</b>
<b>RENAULT Scénic (Mk. IV), 5-dr MPV, 17-</b>				<b>1166 mm / 45 7/8"</b>	

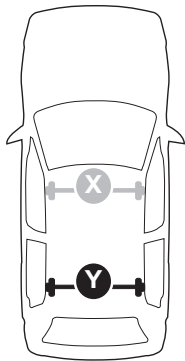

THULE WingBar Evo	THULE WingBar Edge	THULE WingBar	THULE SquareBar Evo	<b>Evo Y (scale)</b>	<b>Edge Y (scale)</b>
<b>RENAULT Scénic (Mk. IV), 5-dr MPV, 17-</b>				<b>42,5</b>	<b>L</b>
THULE ProBar Evo	THULE SlideBar Evo				<b>Y (mm/inch)</b>
<b>RENAULT Scénic (Mk. IV), 5-dr MPV, 17-</b>				<b>1076 mm / 42 3/8"</b>	

	<b>W (mm/inch)</b>	<b>Z (mm/inch)</b>
<b>RENAULT Scénic (Mk. IV), 5-dr MPV, 17-</b>	<b>725 mm / 28 1/2"</b>	<b>235 mm / 9 1/4"</b>

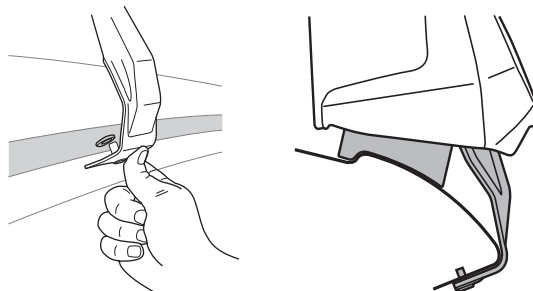
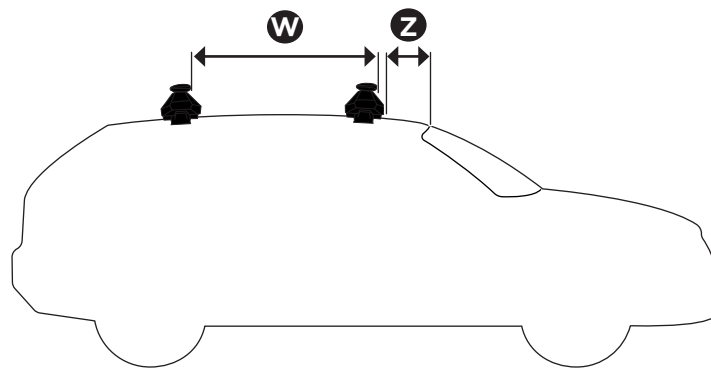

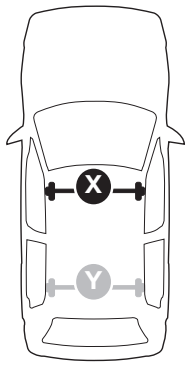

THULE WingBar Evo	THULE WingBar Edge	THULE WingBar	THULE SquareBar Evo	<b>Evo X (scale)</b>	<b>Edge X (scale)</b>
<b>AUDI Q2, 5-dr SUV, 17-</b>				<b>41</b>	<b>O</b>
THULE ProBar Evo	THULE SlideBar Evo				<b>X (mm/inch)</b>
<b>AUDI Q2, 5-dr SUV, 17-</b>				<b>1061 mm / 41 3/4"</b>	

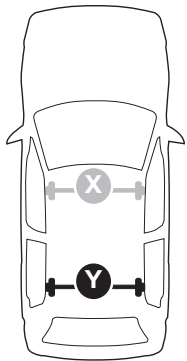

THULE WingBar Evo	THULE WingBar Edge	THULE WingBar	THULE SquareBar Evo	<b>Evo Y (scale)</b>	<b>Edge Y (scale)</b>
<b>AUDI Q2, 5-dr SUV, 17-</b>				<b>34,5</b>	<b>J</b>
THULE ProBar Evo	THULE SlideBar Evo				<b>Y (mm/inch)</b>
<b>AUDI Q2, 5-dr SUV, 17-</b>				<b>996 mm / 39 1/4"</b>	

	<b>W (mm/inch)</b>	<b>Z (mm/inch)</b>
<b>AUDI Q2, 5-dr SUV, 17-</b>	<b>720 mm / 28 3/8"</b>	<b>240 mm / 9 1/2"</b>

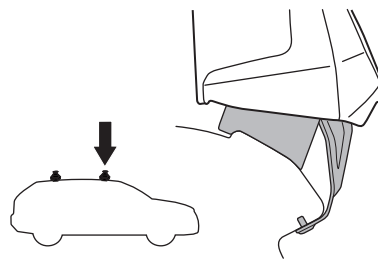
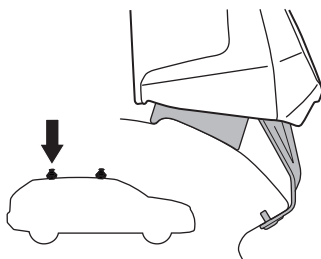
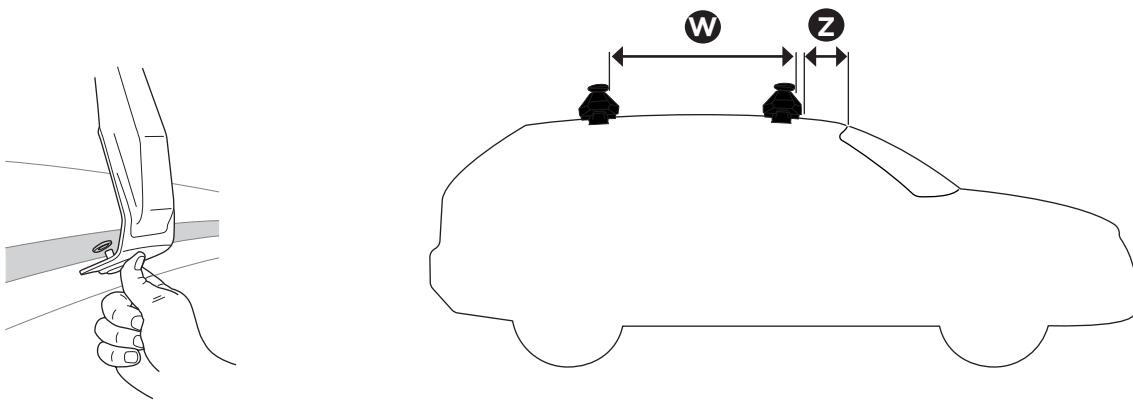

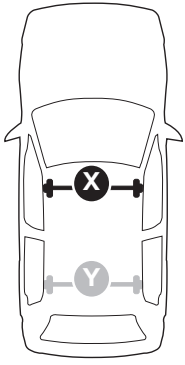

THULE WingBar Evo	THULE WingBar Edge	THULE WingBar	THULE SquareBar Evo	<b>Evo X (scale)</b>	<b>Edge X (scale)</b>
<b>CITROËN C3, 5-dr Hatchback, 17-</b>				<b>35</b>	<b>I</b>
THULE ProBar Evo	THULE SlideBar Evo				<b>X (mm/inch)</b>
<b>CITROËN C3, 5-dr Hatchback, 17-</b>				<b>1001 mm / 39 3/8"</b>	

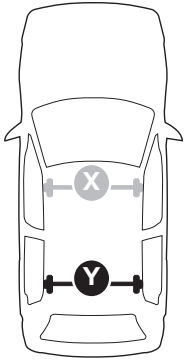

THULE WingBar Evo	THULE WingBar Edge	THULE WingBar	THULE SquareBar Evo	<b>Evo Y (scale)</b>	<b>Edge Y (scale)</b>
<b>CITROËN C3, 5-dr Hatchback, 17-</b>				<b>31</b>	<b>Q</b>
THULE ProBar Evo	THULE SlideBar Evo				<b>Y (mm/inch)</b>
<b>CITROËN C3, 5-dr Hatchback, 17-</b>				<b>961 mm / 37 7/8"</b>	

	<b>W (mm/inch)</b>	<b>Z (mm/inch)</b>
<b>CITROËN C3, 5-dr Hatchback, 17-</b>	<b>725 mm / 28 1/2"</b>	<b>260 mm / 10 1/4"</b>

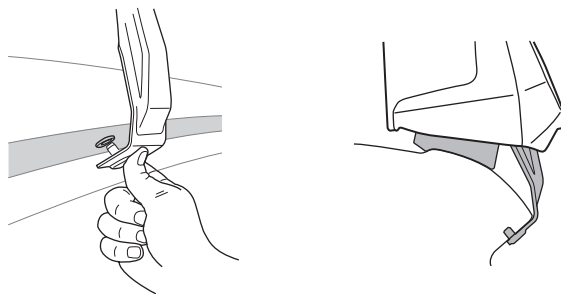
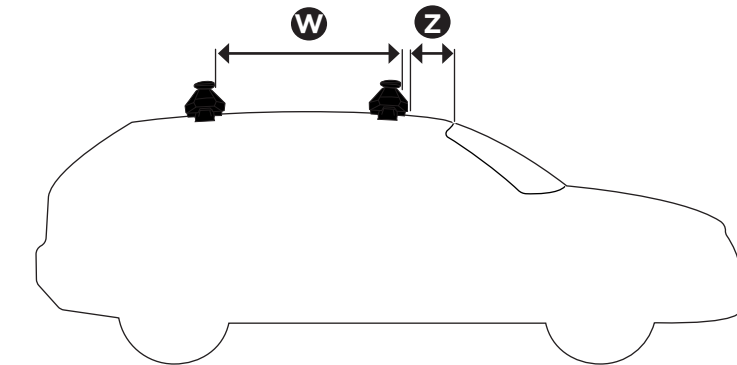

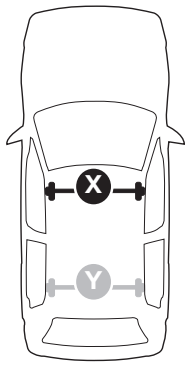

THULE WingBar Evo	THULE WingBar Edge	THULE WingBar	THULE SquareBar Evo	<b>Evo X (scale)</b>	<b>Edge X (scale)</b>
<b>HONDA CR-V, 5-dr SUV, *17- / 19-</b>				<b>47,5</b>	<b>B</b>

THULE ProBar Evo	THULE SlideBar Evo	<b>X (mm/inch)</b>		
<b>HONDA CR-V, 5-dr SUV, *17- / 19-</b>		<b>1126 mm / 44 3/8"</b>		

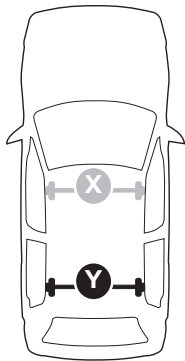

THULE WingBar Evo	THULE WingBar Edge	THULE WingBar	THULE SquareBar Evo	<b>Evo Y (scale)</b>	<b>Edge Y (scale)</b>
<b>HONDA CR-V, 5-dr SUV, *17- / 19-</b>				<b>40,5</b>	<b>P</b>

THULE ProBar Evo	THULE SlideBar Evo	<b>Y (mm/inch)</b>		
<b>HONDA CR-V, 5-dr SUV, *17- / 19-</b>		<b>1056 mm / 41 5/8"</b>		

	<b>W (mm/inch)</b>	<b>Z (mm/inch)</b>
<b>HONDA CR-V, 5-dr SUV, *17- / 19-</b>	<b>700 mm / 27 1/2"</b>	<b>290 mm / 11 3/8"</b>

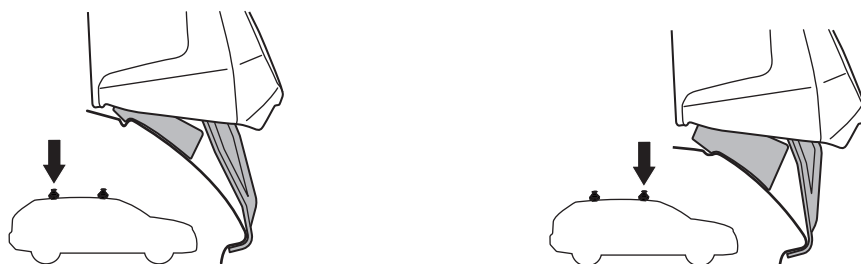
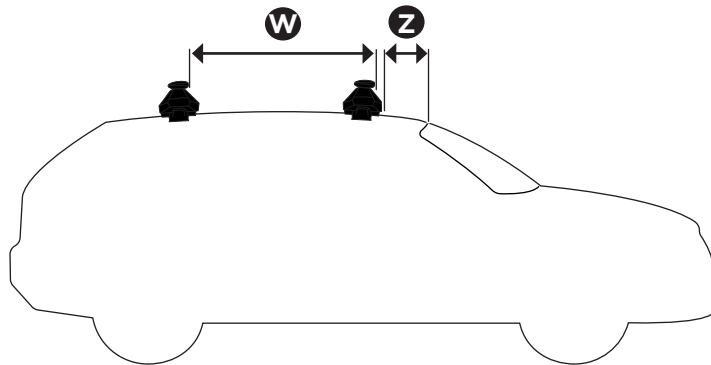

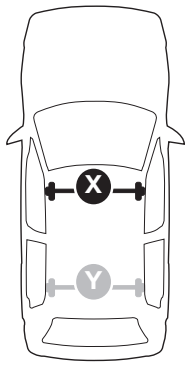

THULE WingBar Evo	THULE WingBar Edge	THULE WingBar	THULE SquareBar Evo	<b>Evo X (scale)</b>	<b>Edge X (scale)</b>
<b>SEAT Ibiza (Mk. V), 5-dr Hatchback, 17-</b>				<b>41,5</b>	<b>N</b>

THULE ProBar Evo	THULE SlideBar Evo	<b>X (mm/inch)</b>		
<b>SEAT Ibiza (Mk. V), 5-dr Hatchback, 17-</b>		<b>1066 mm / 42"</b>		

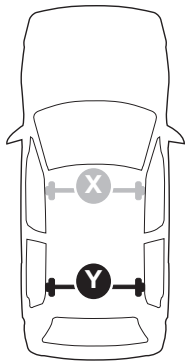

THULE WingBar Evo	THULE WingBar Edge	THULE WingBar	THULE SquareBar Evo	<b>Evo Y (scale)</b>	<b>Edge Y (scale)</b>
<b>SEAT Ibiza (Mk. V), 5-dr Hatchback, 17-</b>				<b>34,5</b>	<b>J</b>

THULE ProBar Evo	THULE SlideBar Evo	<b>Y (mm/inch)</b>		
<b>SEAT Ibiza (Mk. V), 5-dr Hatchback, 17-</b>		<b>996 mm / 39 1/4"</b>		

	<b>W (mm/inch)</b>	<b>Z (mm/inch)</b>
<b>SEAT Ibiza (Mk. V), 5-dr Hatchback, 17-</b>	<b>685 mm / 27"</b>	<b>225 mm / 8 7/8"</b>

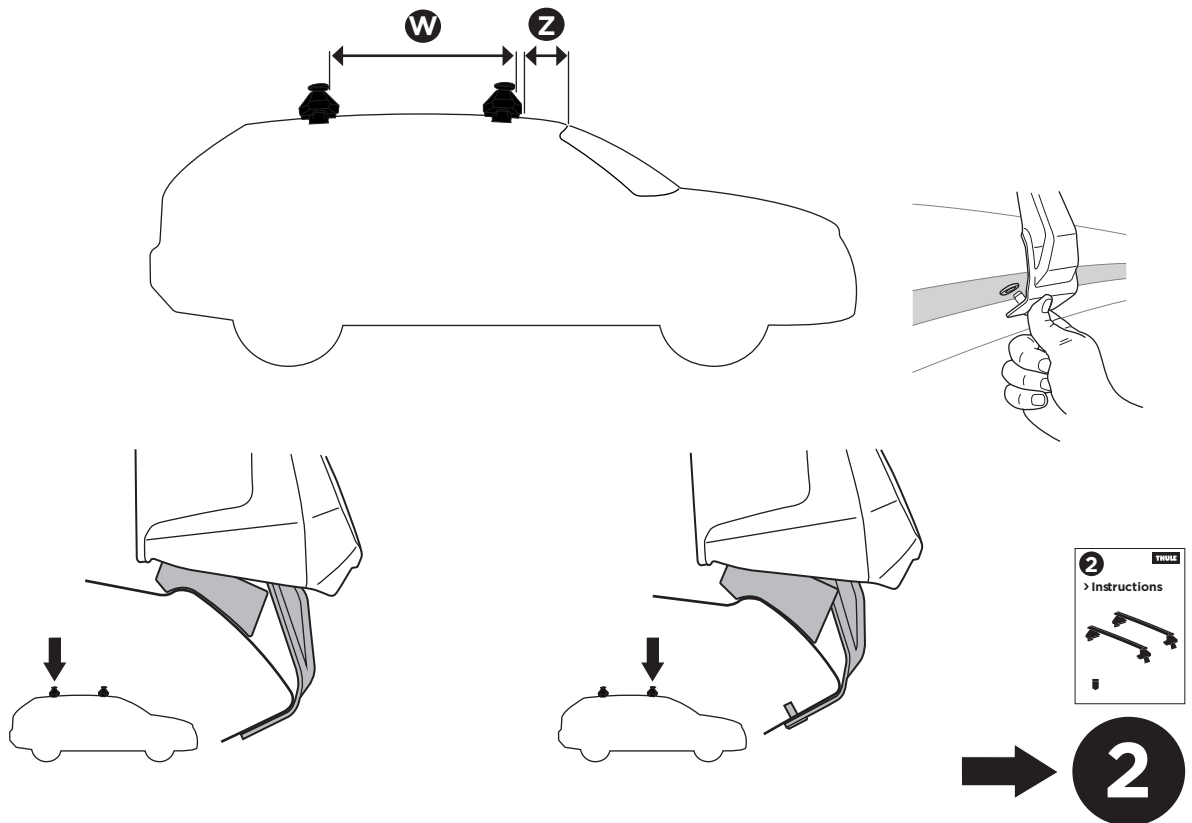

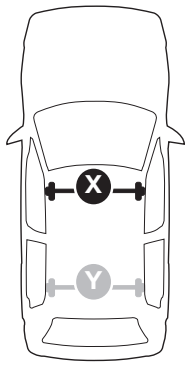

THULE WingBar Evo	THULE WingBar Edge	THULE WingBar	THULE SquareBar Evo	<b>Evo X (scale)</b>	<b>Edge X (scale)</b>
<b>TOYOTA C-HR, 5-dr SUV, 17-</b>				<b>37,5</b>	<b>D</b>
THULE ProBar Evo	THULE SlideBar Evo				<b>X (mm/inch)</b>
<b>TOYOTA C-HR, 5-dr SUV, 17-</b>				<b>1026 mm / 40 3/8"</b>	

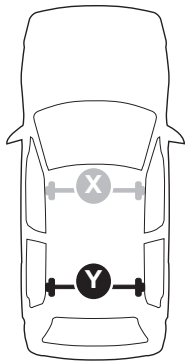

THULE WingBar Evo	THULE WingBar Edge	THULE WingBar	THULE SquareBar Evo	<b>Evo Y (scale)</b>	<b>Edge Y (scale)</b>
<b>TOYOTA C-HR, 5-dr SUV, 17-</b>				<b>34</b>	<b>K</b>
THULE ProBar Evo	THULE SlideBar Evo				<b>Y (mm/inch)</b>
<b>TOYOTA C-HR, 5-dr SUV, 17-</b>				<b>991 mm / 39 "</b>	

	<b>W (mm/inch)</b>	<b>Z (mm/inch)</b>
<b>TOYOTA C-HR, 5-dr SUV, 17-</b>	<b>780 mm / 30 3/4"</b>	<b>225 mm / 8 7/8"</b>

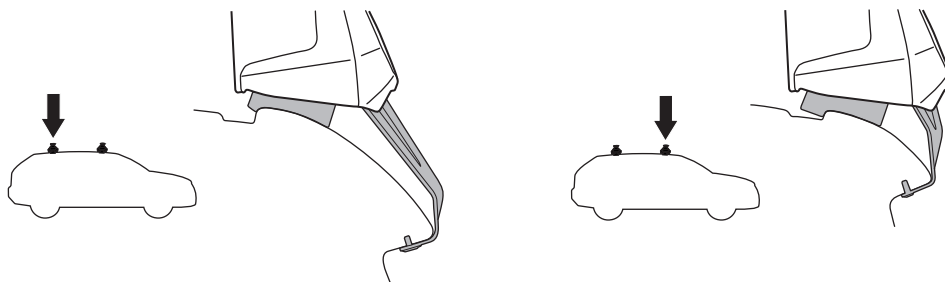
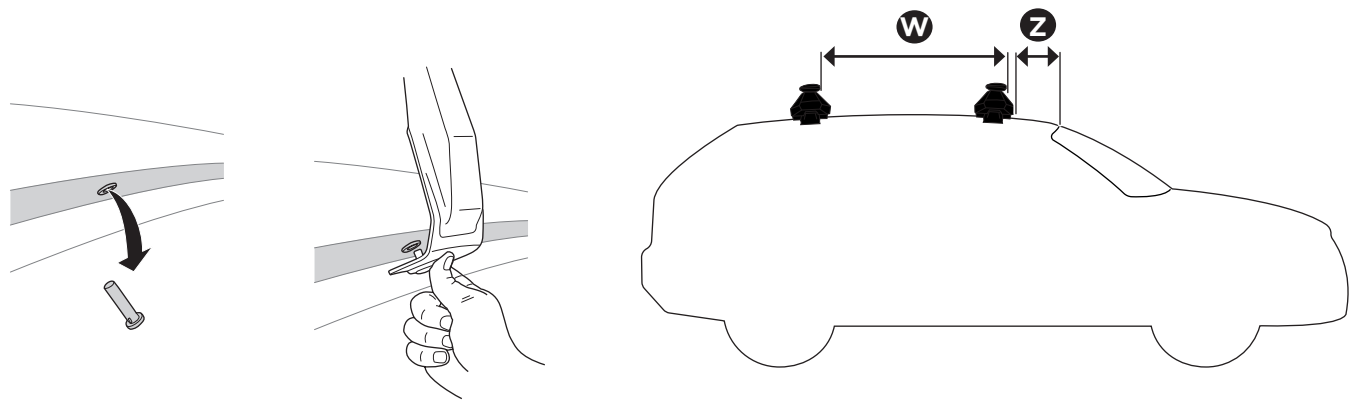

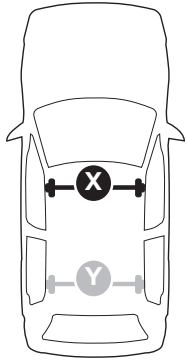

THULE WingBar Evo	THULE WingBar Edge	THULE WingBar	THULE SquareBar Evo	<b>Evo X (scale)</b>	<b>Edge X (scale)</b>
<b>PORSCHE Panamera, 5-dr Hatchback, 17-</b>				<b>44</b>	<b>I</b>

THULE ProBar Evo	THULE SlideBar Evo			<b>X (mm/inch)</b>
<b>PORSCHE Panamera, 5-dr Hatchback, 17-</b>				<b>1091 mm / 43"</b>

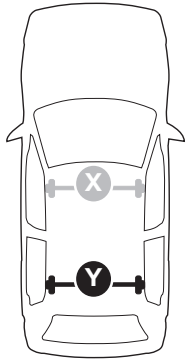

THULE WingBar Evo	THULE WingBar Edge	THULE WingBar	THULE SquareBar Evo	<b>Evo Y (scale)</b>	<b>Edge Y (scale)</b>
<b>PORSCHE Panamera, 5-dr Hatchback, 17-</b>				<b>36,5</b>	<b>F</b>

THULE ProBar Evo	THULE SlideBar Evo			<b>Y (mm/inch)</b>
<b>PORSCHE Panamera, 5-dr Hatchback, 17-</b>				<b>1016 mm / 40"</b>

	<b>W (mm/inch)</b>	<b>Z (mm/inch)</b>
<b>PORSCHE Panamera, 5-dr Hatchback, 17-</b>	<b>755 mm / 29 3/4"</b>	<b>180 mm / 7 1/8"</b>

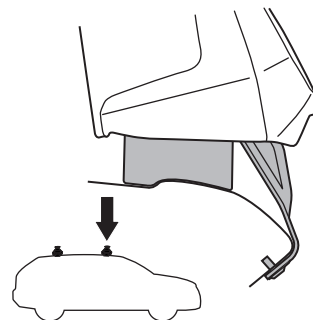
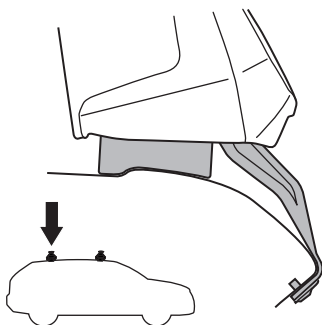
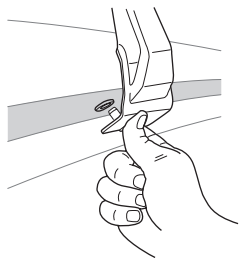
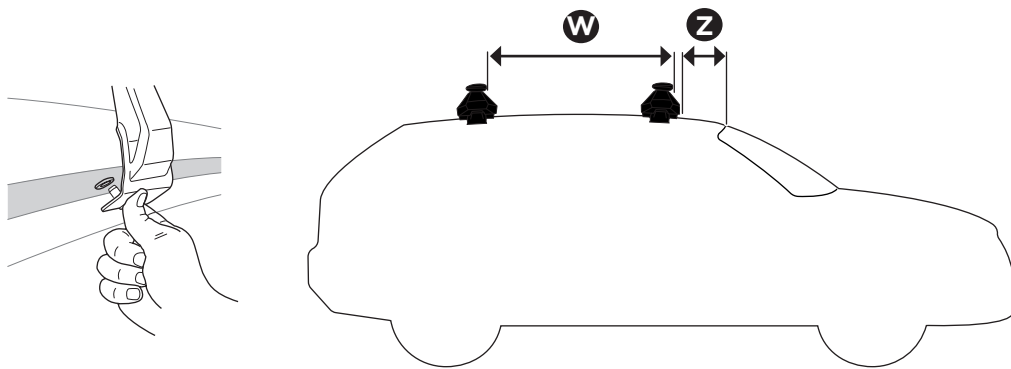
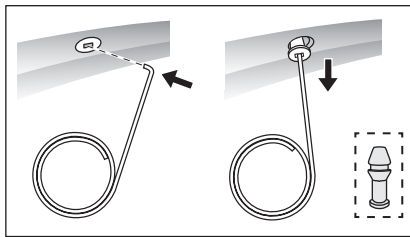
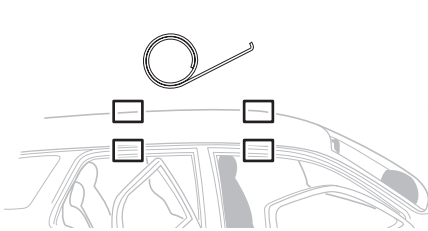

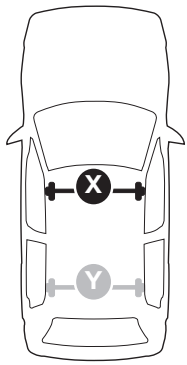

THULE WingBar Evo	THULE WingBar Edge	THULE WingBar	THULE SquareBar Evo	<b>Evo X (scale)</b>	<b>Edge X (scale)</b>
<b>KIA Sportage, 5-dr SUV, 16-</b>				<b>43</b>	<b>K</b>
THULE ProBar Evo	THULE SlideBar Evo				<b>X (mm/inch)</b>
<b>KIA Sportage, 5-dr SUV, 16-</b>				<b>1081 mm / 42 1/2"</b>	

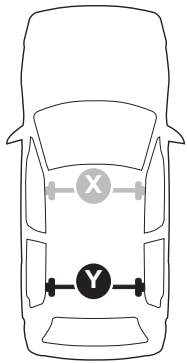

THULE WingBar Evo	THULE WingBar Edge	THULE WingBar	THULE SquareBar Evo	<b>Evo Y (scale)</b>	<b>Edge Y (scale)</b>
<b>KIA Sportage, 5-dr SUV, 16-</b>				<b>39,5</b>	<b>R</b>
THULE ProBar Evo	THULE SlideBar Evo				<b>Y (mm/inch)</b>
<b>KIA Sportage, 5-dr SUV, 16-</b>				<b>1046 mm / 41 1/8"</b>	

	<b>W (mm/inch)</b>	<b>Z (mm/inch)</b>
<b>KIA Sportage, 5-dr SUV, 16-</b>	<b>750 mm / 29 1/2"</b>	<b>250 mm / 9 7/8"</b>

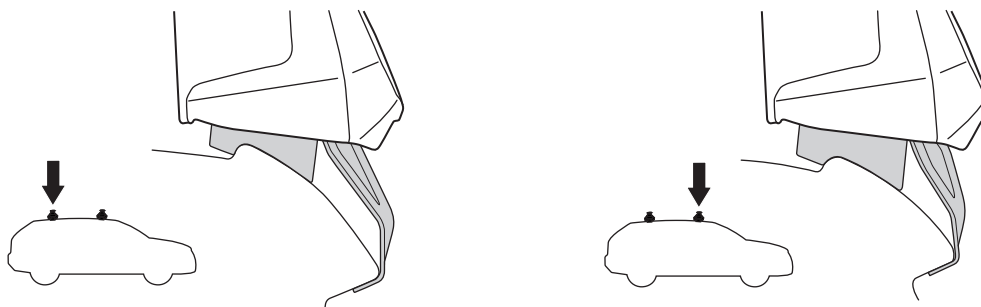
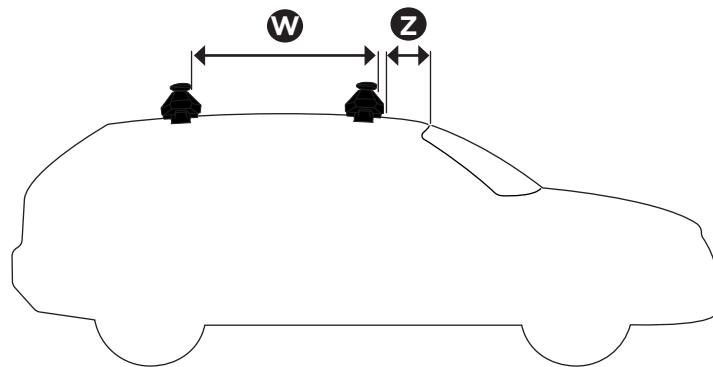

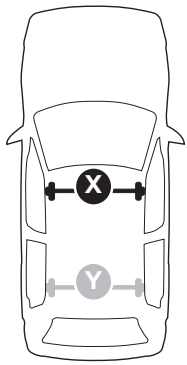

THULE WingBar Evo	THULE WingBar Edge	THULE WingBar	THULE SquareBar Evo	<b>Evo X (scale)</b>	<b>Edge X (scale)</b>
<b>VOLKSWAGEN Polo (Mk. IV), 5-dr Hatchback, 02-09</b>				<b>32</b>	<b>0</b>

THULE ProBar Evo	THULE SlideBar Evo	<b>X (mm/inch)</b>		
<b>VOLKSWAGEN Polo (Mk. IV), 5-dr Hatchback, 02-09</b>		<b>971 mm / 38 1/4"</b>		

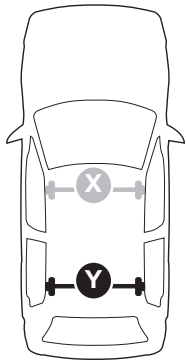

THULE WingBar Evo	THULE WingBar Edge	THULE WingBar	THULE SquareBar Evo	<b>Evo Y (scale)</b>	<b>Edge Y (scale)</b>
<b>VOLKSWAGEN Polo (Mk. IV), 5-dr Hatchback, 02-09</b>				<b>28</b>	<b>E</b>

THULE ProBar Evo	THULE SlideBar Evo	<b>Y (mm/inch)</b>		
<b>VOLKSWAGEN Polo (Mk. IV), 5-dr Hatchback, 02-09</b>		<b>931 mm / 36 5/8"</b>		

	<b>W (mm/inch)</b>	<b>Z (mm/inch)</b>
<b>VOLKSWAGEN Polo (Mk. IV), 5-dr Hatchback, 02-09</b>	<b>780 mm / 30 3/4"</b>	<b>245 mm / 9 5/8"</b>

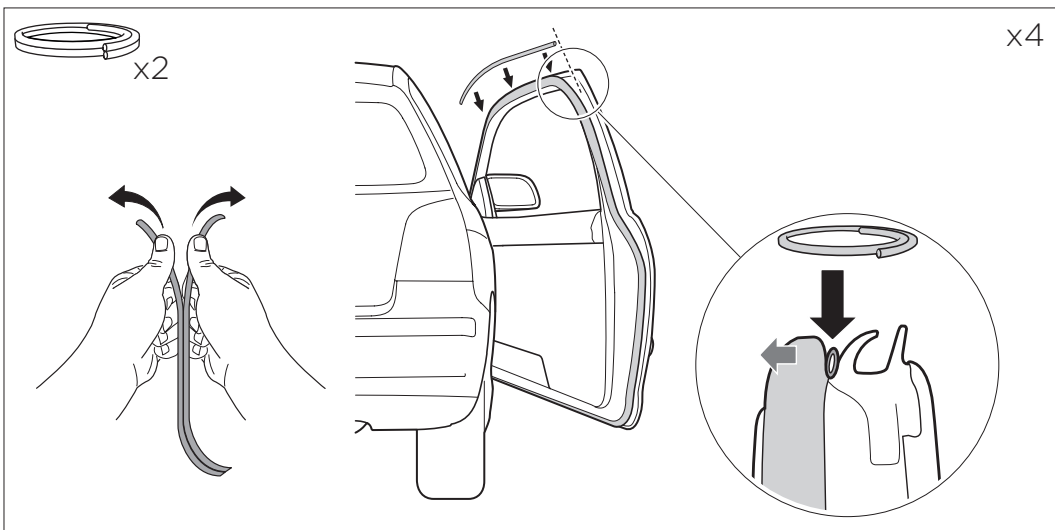
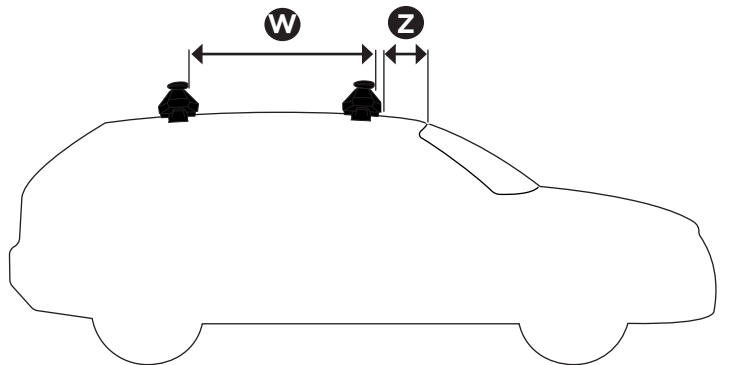
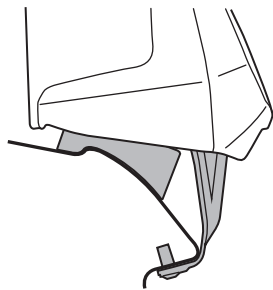
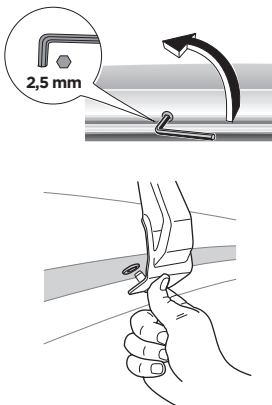

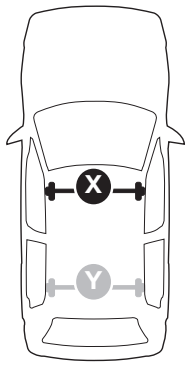

THULE WingBar Evo	THULE WingBar Edge	THULE WingBar	THULE SquareBar Evo	<b>Evo X (scale)</b>	<b>Edge X (scale)</b>
<b>KIA Rio, 5-dr Hatchback, 17- / *18-</b>				<b>41</b>	<b>O</b>

THULE ProBar Evo	THULE SlideBar Evo	<b>X (mm/inch)</b>		
<b>KIA Rio, 5-dr Hatchback, 17- / *18-</b>		<b>1061 mm / 41 3/4"</b>		

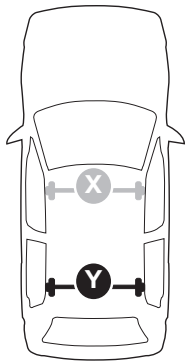

THULE WingBar Evo	THULE WingBar Edge	THULE WingBar	THULE SquareBar Evo	<b>Evo Y (scale)</b>	<b>Edge Y (scale)</b>
<b>KIA Rio, 5-dr Hatchback, 17- / *18-</b>				<b>33</b>	<b>M</b>

THULE ProBar Evo	THULE SlideBar Evo	<b>Y (mm/inch)</b>		
<b>KIA Rio, 5-dr Hatchback, 17- / *18-</b>		<b>981 mm / 38 5/8"</b>		

	<b>W (mm/inch)</b>	<b>Z (mm/inch)</b>
<b>KIA Rio, 5-dr Hatchback, 17- / *18-</b>	<b>675 mm / 26 5/8"</b>	<b>195 mm / 7 5/8"</b>
<b>KIA Rio, 4-dr Sedan, *18-</b>	<b>780 mm / 30 3/4"</b>	<b>195 mm / 7 5/8"</b>

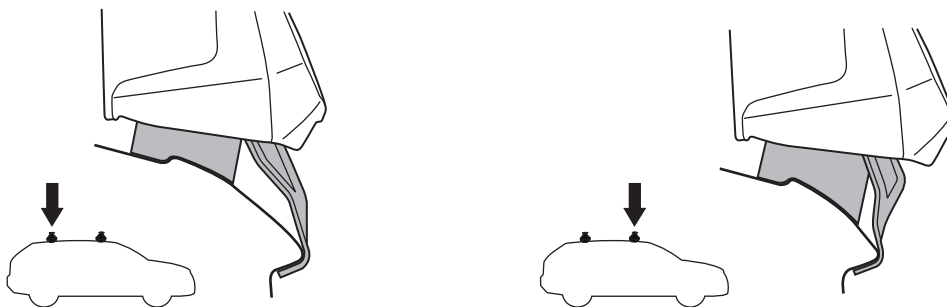
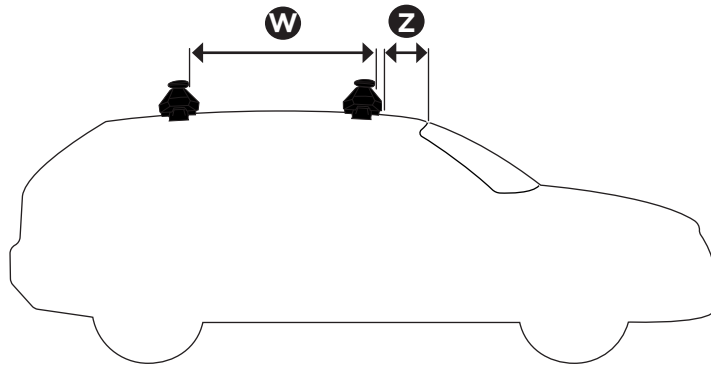

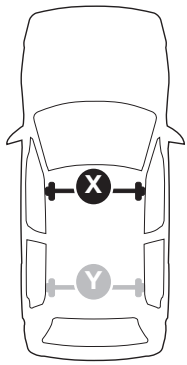

	THULE WingBar Evo	THULE WingBar Edge	THULE WingBar	THULE SquareBar Evo	Evo X (scale)	Edge X (scale)
KIA Morning, 5-dr Hatchback, 17-					32	0
KIA Picanto, 5-dr Hatchback, 17-					32	0

	THULE ProBar Evo	THULE SlideBar Evo	X (mm/inch)
KIA Morning, 5-dr Hatchback, 17-			971 / 38 1/4"
KIA Picanto, 5-dr Hatchback, 17-			971 / 38 1/4"

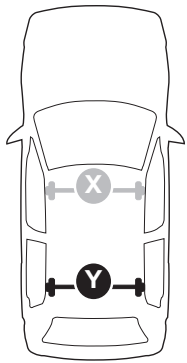

	THULE WingBar Evo	THULE WingBar Edge	THULE WingBar	THULE SquareBar Evo	Evo Y (scale)	Edge Y (scale)
KIA Morning, 5-dr Hatchback, 17-					28	E
KIA Picanto, 5-dr Hatchback, 17-					28	E

	THULE ProBar Evo	THULE SlideBar Evo	Y (mm/inch)
KIA Morning, 5-dr Hatchback, 17-			931 / 36 5/8"
KIA Picanto, 5-dr Hatchback, 17-			931 / 36 5/8"

	W (mm/inch)	Z (mm/inch)
KIA Morning, 5-dr Hatchback, 17-	670 / 26 3/8"	175 / 6 7/8"
KIA Picanto, 5-dr Hatchback, 17-	670 / 26 3/8"	175 / 6 7/8"

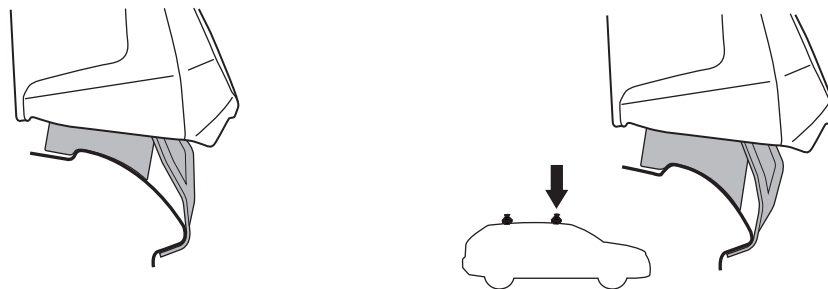
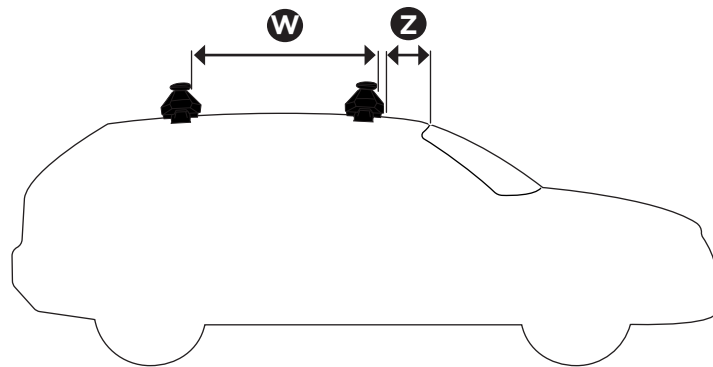

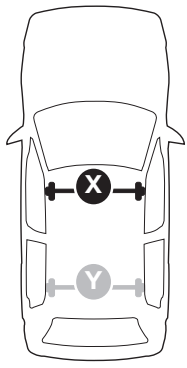

THULE WingBar Evo	THULE WingBar Edge	THULE WingBar	THULE SquareBar Evo	<b>Evo X (scale)</b>	<b>Edge X (scale)</b>
<b>FORD Fiesta, 5-dr Hatchback, 18-</b>				<b>37</b>	<b>E</b>
THULE ProBar Evo	THULE SlideBar Evo				<b>X (mm/inch)</b>
<b>FORD Fiesta, 5-dr Hatchback, 18-</b>				<b>1021 mm / 40 1/4"</b>	

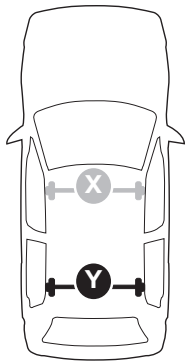

THULE WingBar Evo	THULE WingBar Edge	THULE WingBar	THULE SquareBar Evo	<b>Evo Y (scale)</b>	<b>Edge Y (scale)</b>
<b>FORD Fiesta, 5-dr Hatchback, 18-</b>				<b>30</b>	<b>A</b>
THULE ProBar Evo	THULE SlideBar Evo				<b>Y (mm/inch)</b>
<b>FORD Fiesta, 5-dr Hatchback, 18-</b>				<b>951 mm / 37 1/2"</b>	

	<b>W (mm/inch)</b>	<b>Z (mm/inch)</b>
<b>FORD Fiesta, 5-dr Hatchback, 18-</b>	<b>675 mm / 26 5/8"</b>	<b>175 mm / 6 3/4"</b>

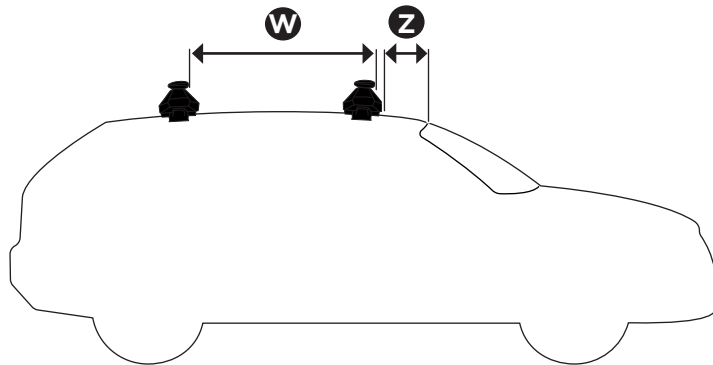

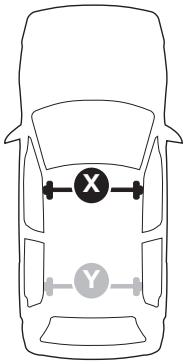

THULE WingBar Evo	THULE WingBar Edge	THULE WingBar	THULE SquareBar Evo	<b>Evo X (scale)</b>	<b>Edge X (scale)</b>
<b>ALFA ROMEO Giulia, 4-dr Sedan, 16-</b>				<b>34,5</b>	<b>J</b>

THULE ProBar Evo	THULE SlideBar Evo				<b>X (mm/inch)</b>
<b>ALFA ROMEO Giulia, 4-dr Sedan, 16-</b>				<b>996 mm / 39 1/4"</b>	

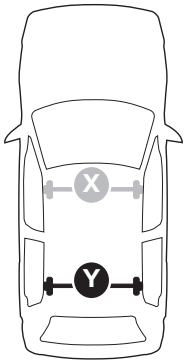

THULE WingBar Evo	THULE WingBar Edge	THULE WingBar	THULE SquareBar Evo	<b>Evo Y (scale)</b>	<b>Edge Y (scale)</b>
<b>ALFA ROMEO Giulia, 4-dr Sedan, 16-</b>				<b>30,5</b>	<b>R</b>

THULE ProBar Evo	THULE SlideBar Evo				<b>Y (mm/inch)</b>
<b>ALFA ROMEO Giulia, 4-dr Sedan, 16-</b>				<b>956 mm / 37 5/8"</b>	

	<b>W (mm/inch)</b>	<b>Z (mm/inch)</b>
<b>ALFA ROMEO Giulia, 4-dr Sedan, 16-</b>	<b>780 mm / 30 3/4"</b>	<b>235 mm / 9 1/4"</b>

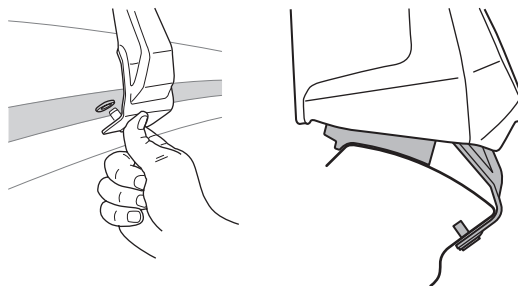
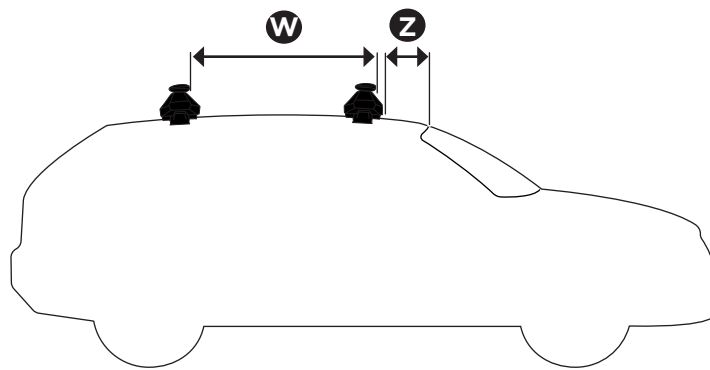

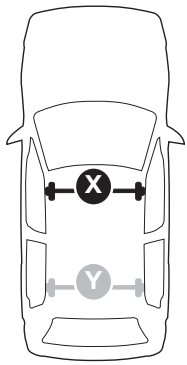

THULE WingBar Evo	THULE WingBar Edge	THULE WingBar	THULE SquareBar Evo	<b>Evo X (scale)</b>	<b>Edge X (scale)</b>
<b>TOYOTA RAV4, 5-dr SUV, 13-15, 16-18</b>				<b>44</b>	<b>I</b>
THULE ProBar Evo	THULE SlideBar Evo				<b>X (mm/inch)</b>
<b>TOYOTA RAV4, 5-dr SUV, 13-15, 16-18</b>				<b>1091 mm / 43"</b>	

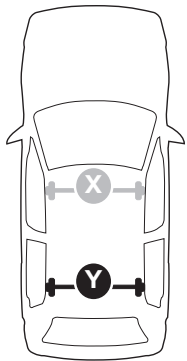

THULE WingBar Evo	THULE WingBar Edge	THULE WingBar	THULE SquareBar Evo	<b>Evo Y (scale)</b>	<b>Edge Y (scale)</b>
<b>TOYOTA RAV4, 5-dr SUV, 13-15, 16-18</b>				<b>36,5</b>	<b>F</b>
THULE ProBar Evo	THULE SlideBar Evo				<b>Y (mm/inch)</b>
<b>TOYOTA RAV4, 5-dr SUV, 13-15, 16-18</b>				<b>1016 mm / 40"</b>	

	<b>W (mm/inch)</b>	<b>Z (mm/inch)</b>
<b>TOYOTA RAV4, 5-dr SUV, 13-15, 16-18</b>	<b>700 mm / 27 1/2"</b>	<b>350 mm / 13 3/4"</b>

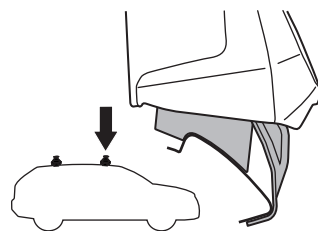
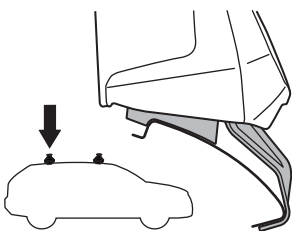
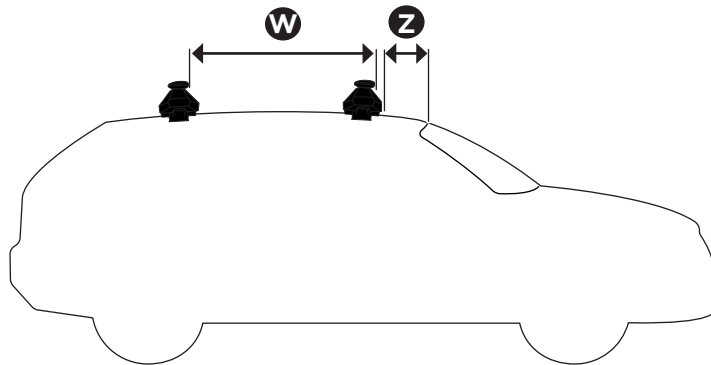

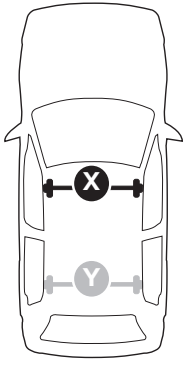

THULE WingBar Evo	THULE WingBar Edge	THULE WingBar	THULE SquareBar Evo	<b>Evo X (scale)</b>	<b>Edge X (scale)</b>
<b>HYUNDAI Santa Fe, 5-dr SUV, 13-18</b>				<b>47,5</b>	<b>B</b>

THULE ProBar Evo	THULE SlideBar Evo	<b>X (mm/inch)</b>		
<b>HYUNDAI Santa Fe, 5-dr SUV, 13-18</b>		<b>1126 mm / 44 3/8"</b>		

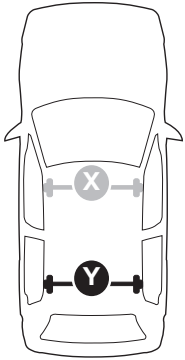

THULE WingBar Evo	THULE WingBar Edge	THULE WingBar	THULE SquareBar Evo	<b>Evo Y (scale)</b>	<b>Edge Y (scale)</b>
<b>HYUNDAI Santa Fe, 5-dr SUV, 13-18</b>				<b>44,5</b>	<b>H</b>

THULE ProBar Evo	THULE SlideBar Evo	<b>Y (mm/inch)</b>		
<b>HYUNDAI Santa Fe, 5-dr SUV, 13-18</b>		<b>1096 mm / 43 1/8"</b>		

	<b>W (mm/inch)</b>	<b>Z (mm/inch)</b>
<b>HYUNDAI Santa Fe, 5-dr SUV, 13-18</b>	<b>700 mm / 27 1/2"</b>	<b>270 mm / 10 5/8"</b>

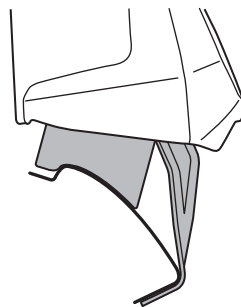
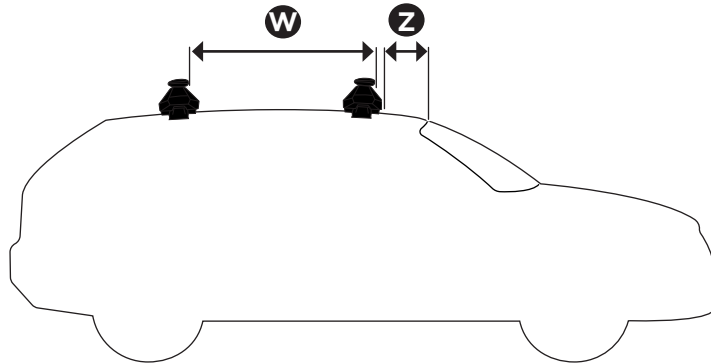

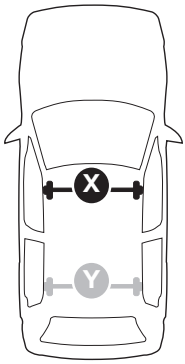

THULE WingBar Evo	THULE WingBar Edge	THULE WingBar	THULE SquareBar Evo	<b>Evo X (scale)</b>	<b>Edge X (scale)</b>
BMW X1 (F48), 5-dr SUV, 16-				46	E

THULE ProBar Evo	THULE SlideBar Evo				<b>X (mm/inch)</b>
BMW X1 (F48), 5-dr SUV, 16-				1111 mm / 43 3/4"	

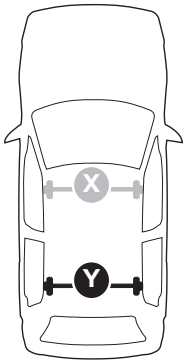

THULE WingBar Evo	THULE WingBar Edge	THULE WingBar	THULE SquareBar Evo	<b>Evo Y (scale)</b>	<b>Edge Y (scale)</b>
BMW X1 (F48), 5-dr SUV, 16-				41,5	N

THULE ProBar Evo	THULE SlideBar Evo				<b>Y (mm/inch)</b>
BMW X1 (F48), 5-dr SUV, 16-				1066 mm / 42"	

	<b>W (mm/inch)</b>	<b>Z (mm/inch)</b>
BMW X1 (F48), 5-dr SUV, 16-	700 mm / 27 1/2"	240 mm / 9 1/2"

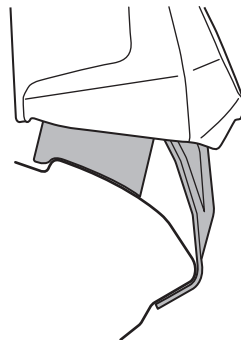
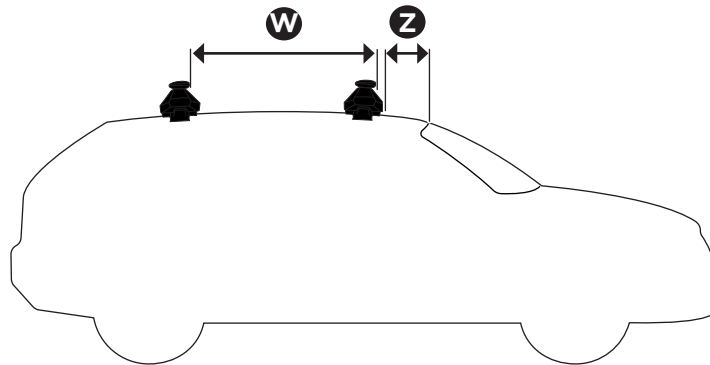

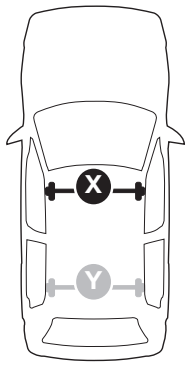

THULE WingBar Evo	THULE WingBar Edge	THULE WingBar	THULE SquareBar Evo	<b>Evo X (scale)</b>	<b>Edge X (scale)</b>
<b>SUBARU Impreza, 4-dr Sedan, 17-</b>				<b>44</b>	<b>I</b>

THULE ProBar Evo	THULE SlideBar Evo	<b>X (mm/inch)</b>		
<b>SUBARU Impreza, 4-dr Sedan, 17-</b>		<b>1091 mm / 43"</b>		

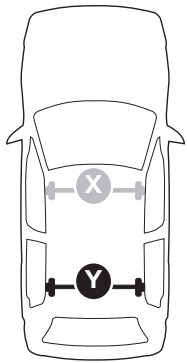

THULE WingBar Evo	THULE WingBar Edge	THULE WingBar	THULE SquareBar Evo	<b>Evo Y (scale)</b>	<b>Edge Y (scale)</b>
<b>SUBARU Impreza, 4-dr Sedan, 17-</b>				<b>39,5</b>	<b>R</b>

THULE ProBar Evo	THULE SlideBar Evo	<b>Y (mm/inch)</b>		
<b>SUBARU Impreza, 4-dr Sedan, 17-</b>		<b>1046 mm / 41 1/8"</b>		

	<b>W (mm/inch)</b>	<b>Z (mm/inch)</b>
<b>SUBARU Impreza, 4-dr Sedan, 17-</b>	<b>750 mm / 29 1/2"</b>	<b>220 mm / 8 5/8"</b>

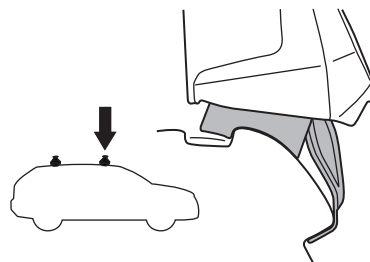
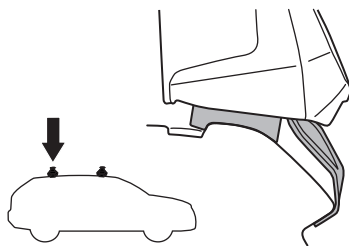
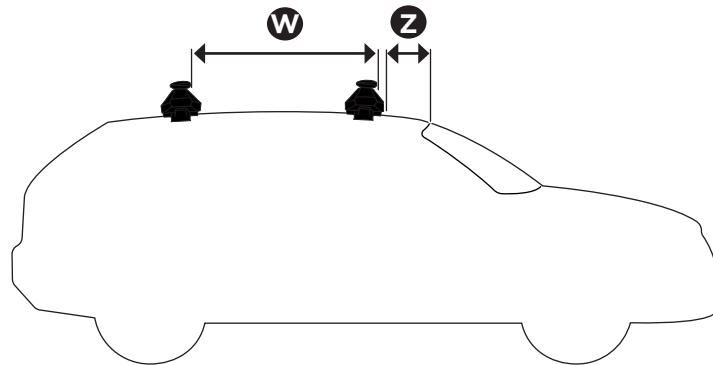

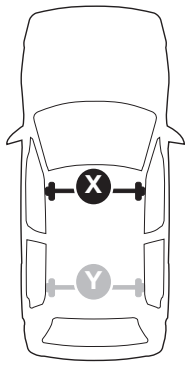

THULE WingBar Evo	THULE WingBar Edge	THULE WingBar	THULE SquareBar Evo	<b>Evo X (scale)</b>	<b>Edge X (scale)</b>
<b>MAZDA CX-9, 5-dr SUV, 16-</b>				<b>50</b>	<b>0</b>

THULE ProBar Evo	THULE SlideBar Evo	<b>X (mm/inch)</b>		
<b>MAZDA CX-9, 5-dr SUV, 16-</b>		<b>1151 mm / 45 3/8"</b>		

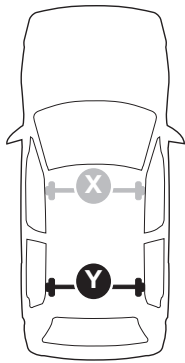

THULE WingBar Evo	THULE WingBar Edge	THULE WingBar	THULE SquareBar Evo	<b>Evo Y (scale)</b>	<b>Edge Y (scale)</b>
<b>MAZDA CX-9, 5-dr SUV, 16-</b>				<b>45,5</b>	<b>F</b>

THULE ProBar Evo	THULE SlideBar Evo	<b>Y (mm/inch)</b>		
<b>MAZDA CX-9, 5-dr SUV, 16-</b>		<b>1106 mm / 43 1/2"</b>		

	<b>W (mm/inch)</b>	<b>Z (mm/inch)</b>
<b>MAZDA CX-9, 5-dr SUV, 16-</b>	<b>720 mm / 28 3/8"</b>	<b>300 mm / 11 3/4"</b>

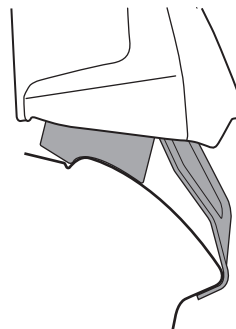
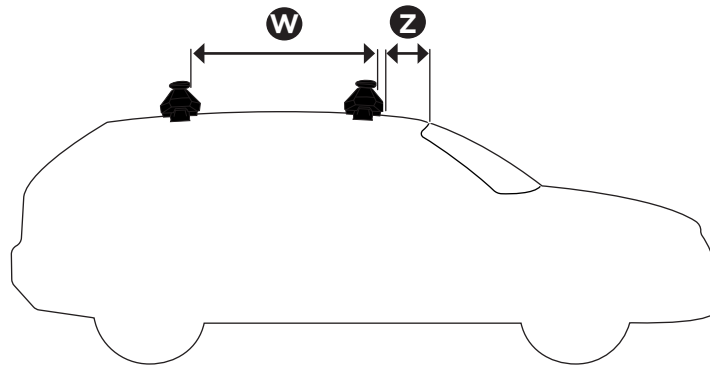

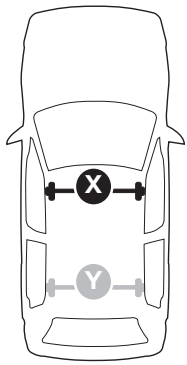

THULE WingBar Evo	THULE WingBar Edge	THULE WingBar	THULE SquareBar Evo	<b>Evo X (scale)</b>	<b>Edge X (scale)</b>
<b>NISSAN Micra, 5-dr Hatchback, 17-</b>				<b>35</b>	<b>I</b>
THULE ProBar Evo	THULE SlideBar Evo				<b>X (mm/inch)</b>
<b>NISSAN Micra, 5-dr Hatchback, 17-</b>				<b>1001 mm / 39 3/8"</b>	

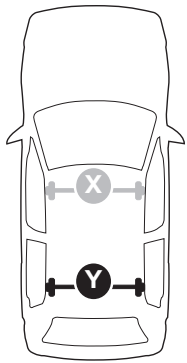

THULE WingBar Evo	THULE WingBar Edge	THULE WingBar	THULE SquareBar Evo	<b>Evo Y (scale)</b>	<b>Edge Y (scale)</b>
<b>NISSAN Micra, 5-dr Hatchback, 17-</b>				<b>30,5</b>	<b>R</b>
THULE ProBar Evo	THULE SlideBar Evo				<b>Y (mm/inch)</b>
<b>NISSAN Micra, 5-dr Hatchback, 17-</b>				<b>956 mm / 37 5/8"</b>	

	<b>W (mm/inch)</b>	<b>Z (mm/inch)</b>
<b>NISSAN Micra, 5-dr Hatchback, 17-</b>	<b>700 mm / 27 1/2"</b>	<b>250 mm / 9 7/8"</b>

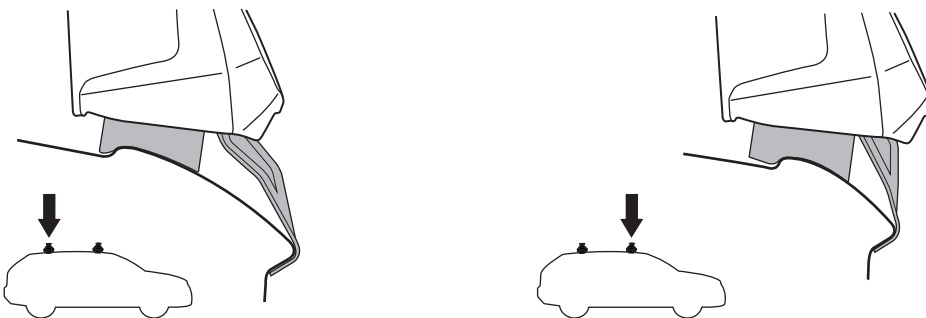
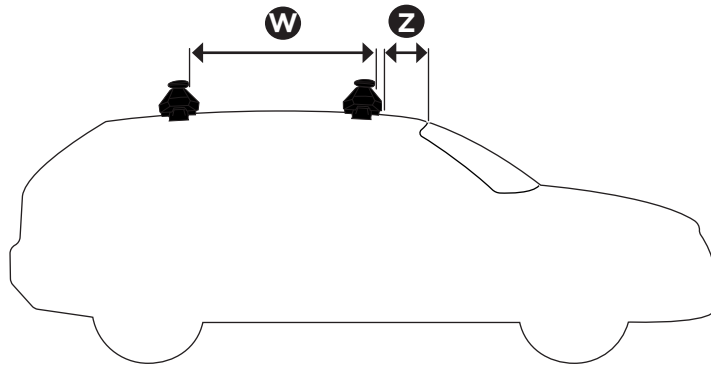

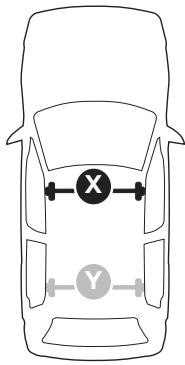

THULE WingBar Evo	THULE WingBar Edge	THULE WingBar	THULE SquareBar Evo	Evo X (scale)	Edge X (scale)
FORD Edge, 5-dr SUV, 15-				50,5	N
FORD Endura, 5-dr SUV, *18-				50,5	N

THULE ProBar Evo	THULE SlideBar Evo	X (mm/inch)	
FORD Edge, 5-dr SUV, 15-		1156 mm / 45 1/2"	
FORD Endura, 5-dr SUV, *18-		1156 mm / 45 1/2"	

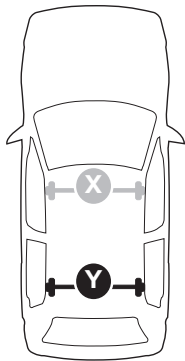

THULE WingBar Evo	THULE WingBar Edge	THULE WingBar	THULE SquareBar Evo	Evo Y (scale)	Edge Y (scale)
FORD Edge, 5-dr SUV, 15-				46,5	D
FORD Endura, 5-dr SUV, *18-				46,5	D

THULE ProBar Evo	THULE SlideBar Evo	Y (mm/inch)	
FORD Edge, 5-dr SUV, 15-		1116 mm / 43 7/8"	
FORD Endura, 5-dr SUV, *18-		1116 mm / 43 7/8"	

	W (mm/inch)	Z (mm/inch)
FORD Edge, 5-dr SUV, 15-	750 mm / 29 1/2"	235 mm / 9 1/4"
FORD Endura, 5-dr SUV, *18-	750 mm / 29 1/2"	235 mm / 9 1/4"



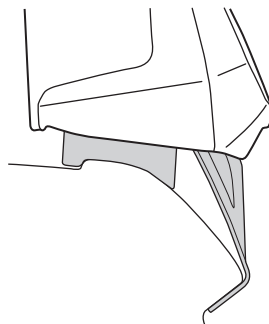
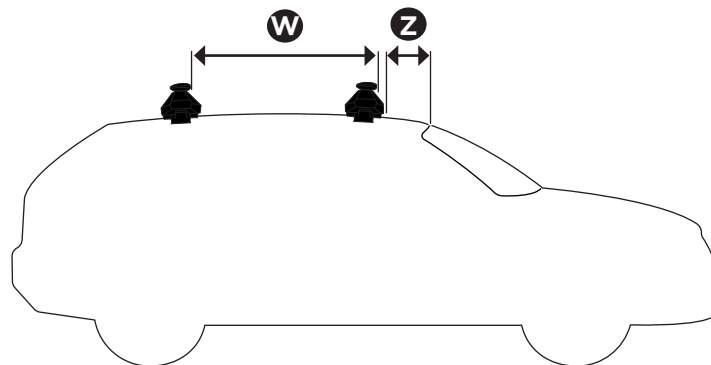

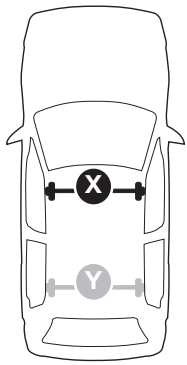
THULE WingBar Evo	THULE WingBar Edge	THULE WingBar	THULE SquareBar Evo	<b>Evo X (scale)</b>	<b>Edge X (scale)</b>
<b>VOLKSWAGEN Arteon, 5-dr Hatchback, 17-</b>				<b>47,5</b>	<b>B</b>

THULE ProBar Evo	THULE SlideBar Evo	<b>X (mm/inch)</b>		
<b>VOLKSWAGEN Arteon, 5-dr Hatchback, 17-</b>		<b>1126 mm / 44 3/8"</b>		

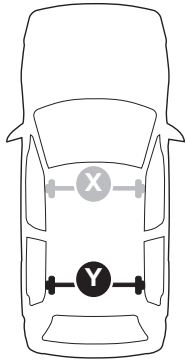

THULE WingBar Evo	THULE WingBar Edge	THULE WingBar	THULE SquareBar Evo	<b>Evo Y (scale)</b>	<b>Edge Y (scale)</b>
<b>VOLKSWAGEN Arteon, 5-dr Hatchback, 17-</b>				<b>44</b>	<b>I</b>

THULE ProBar Evo	THULE SlideBar Evo	<b>Y (mm/inch)</b>		
<b>VOLKSWAGEN Arteon, 5-dr Hatchback, 17-</b>		<b>1091 mm / 43"</b>		

	<b>W (mm/inch)</b>	<b>Z (mm/inch)</b>
<b>VOLKSWAGEN Arteon, 5-dr Hatchback, 17-</b>	<b>755 mm / 29 3/4"</b>	<b>150 mm / 5 7/8"</b>

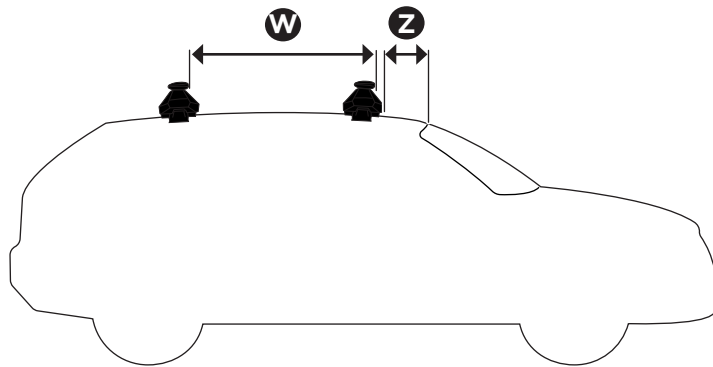

**i**

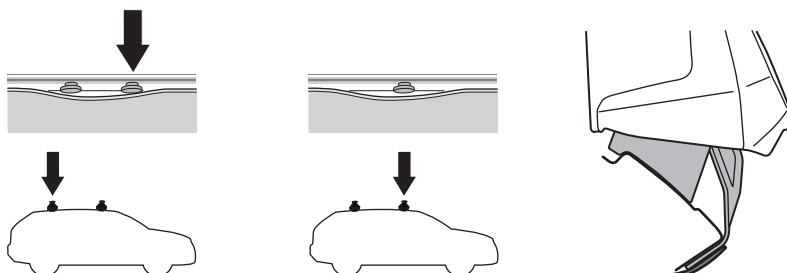
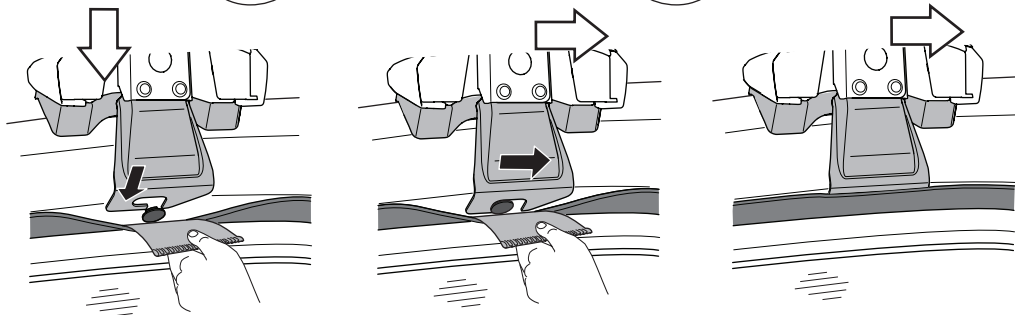

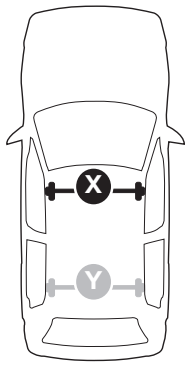

THULE WingBar Evo	THULE WingBar Edge	THULE WingBar	THULE SquareBar Evo	Evo X (scale)	Edge X (scale)
OPEL Crossland X, 5-dr SUV, 17-				40,5	P
VAUXHALL Crossland X, 5-dr SUV, 17-				40,5	P

THULE ProBar Evo	THULE SlideBar Evo	X (mm/inch)
OPEL Crossland X, 5-dr SUV, 17-		1056 mm / 41 5/8"
VAUXHALL Crossland X, 5-dr SUV, 17-		1056 mm / 41 5/8"

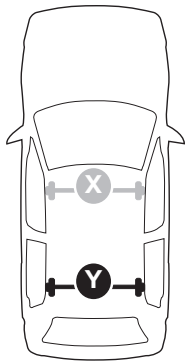

THULE WingBar Evo	THULE WingBar Edge	THULE WingBar	THULE SquareBar Evo	Evo Y (scale)	Edge Y (scale)
OPEL Crossland X, 5-dr SUV, 17-				35	I
VAUXHALL Crossland X, 5-dr SUV, 17-				35	I

THULE ProBar Evo	THULE SlideBar Evo	Y (mm/inch)
OPEL Crossland X, 5-dr SUV, 17-		1001 mm / 39 3/8"
VAUXHALL Crossland X, 5-dr SUV, 17-		1001 mm / 39 3/8"

	W (mm/inch)	Z (mm/inch)
OPEL Crossland X, 5-dr SUV, 17-	725 mm / 28 1/2"	220 mm / 8 5/8"
VAUXHALL Crossland X, 5-dr SUV, 17-	725 mm / 28 1/2"	220 mm / 8 5/8"

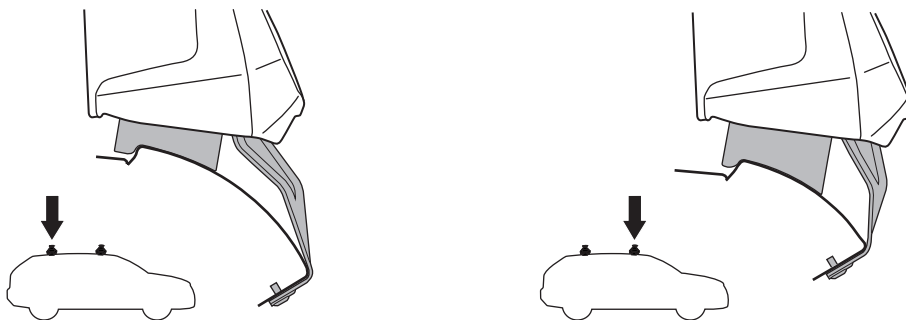
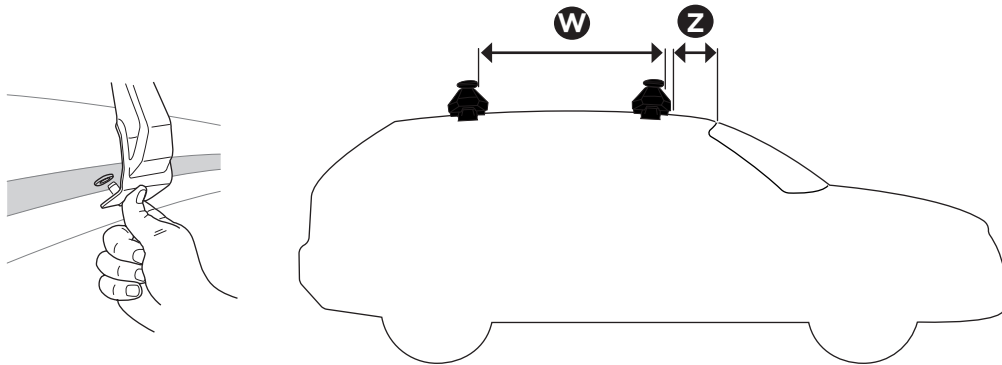

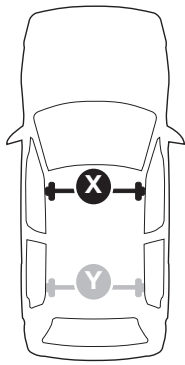

THULE WingBar Evo	THULE WingBar Edge	THULE WingBar	THULE SquareBar Evo	<b>Evo X (scale)</b>	<b>Edge X (scale)</b>
<b>MAZDA CX-5, 5-dr SUV, 17-</b>				<b>44</b>	<b>I</b>
THULE ProBar Evo	THULE SlideBar Evo				<b>X (mm/inch)</b>
<b>MAZDA CX-5, 5-dr SUV, 17-</b>				<b>1091 mm / 43"</b>	

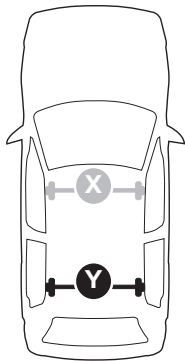

THULE WingBar Evo	THULE WingBar Edge	THULE WingBar	THULE SquareBar Evo	<b>Evo Y (scale)</b>	<b>Edge Y (scale)</b>
<b>MAZDA CX-5, 5-dr SUV, 17-</b>				<b>38</b>	<b>C</b>
THULE ProBar Evo	THULE SlideBar Evo				<b>Y (mm/inch)</b>
<b>MAZDA CX-5, 5-dr SUV, 17-</b>				<b>1031 mm / 40 5/8"</b>	

	<b>W (mm/inch)</b>	<b>Z (mm/inch)</b>
<b>MAZDA CX-5, 5-dr SUV, 17-</b>	<b>700 mm / 27 1/2"</b>	<b>225 mm / 8 7/8"</b>

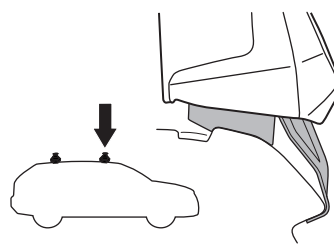
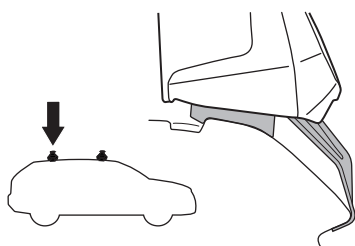
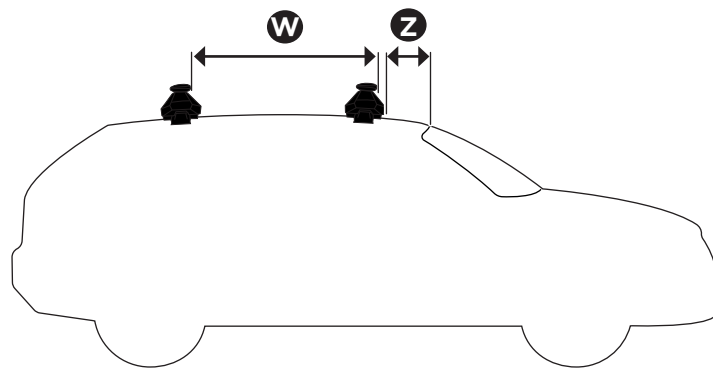

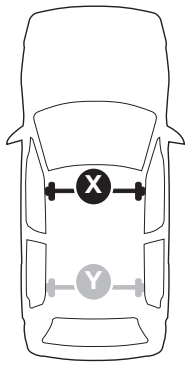

THULE WingBar Evo	THULE WingBar Edge	THULE WingBar	THULE SquareBar Evo	<b>Evo X (scale)</b>	<b>Edge X (scale)</b>
<b>KIA Stinger, 5-dr Hatchback, 18-</b>				<b>44</b>	<b>I</b>
THULE ProBar Evo	THULE SlideBar Evo				<b>X (mm/inch)</b>
<b>KIA Stinger, 5-dr Hatchback, 18-</b>				<b>1091 mm / 43"</b>	

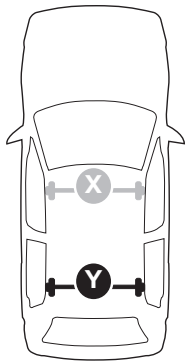

THULE WingBar Evo	THULE WingBar Edge	THULE WingBar	THULE SquareBar Evo	<b>Evo Y (scale)</b>	<b>Edge Y (scale)</b>
<b>KIA Stinger, 5-dr Hatchback, 18-</b>				<b>40</b>	<b>Q</b>
THULE ProBar Evo	THULE SlideBar Evo				<b>Y (mm/inch)</b>
<b>KIA Stinger, 5-dr Hatchback, 18-</b>				<b>1051 mm / 41 3/8"</b>	

	<b>W (mm/inch)</b>	<b>Z (mm/inch)</b>
<b>KIA Stinger, 5-dr Hatchback, 18-</b>	<b>700 mm / 27 1/2"</b>	<b>230 mm / 9"</b>

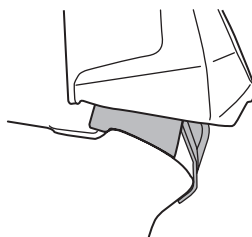
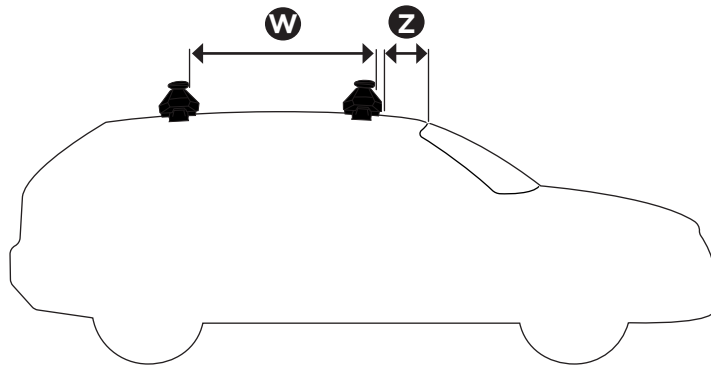

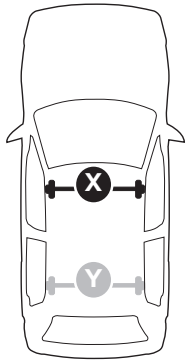

THULE WingBar Evo	THULE WingBar Edge	THULE WingBar	THULE SquareBar Evo	<b>Evo X (scale)</b>	<b>Edge X (scale)</b>
<b>AUDI A6, 4-dr Sedan, 11-18</b>				<b>40,5</b>	<b>P</b>

THULE ProBar Evo	THULE SlideBar Evo	<b>X (mm/inch)</b>		
<b>AUDI A6, 4-dr Sedan, 11-18</b>		<b>1056 mm / 41 5/8"</b>		

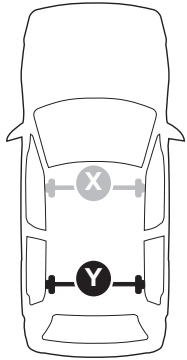

THULE WingBar Evo	THULE WingBar Edge	THULE WingBar	THULE SquareBar Evo	<b>Evo Y (scale)</b>	<b>Edge Y (scale)</b>
<b>AUDI A6, 4-dr Sedan, 11-18</b>				<b>39</b>	<b>A</b>

THULE ProBar Evo	THULE SlideBar Evo	<b>Y (mm/inch)</b>		
<b>AUDI A6, 4-dr Sedan, 11-18</b>		<b>1041 mm / 41"</b>		

	<b>W (mm/inch)</b>	<b>Z (mm/inch)</b>
<b>AUDI A6, 4-dr Sedan, 11-18</b>	<b>720 mm / 28 3/8"</b>	<b>270 mm / 10 5/8"</b>

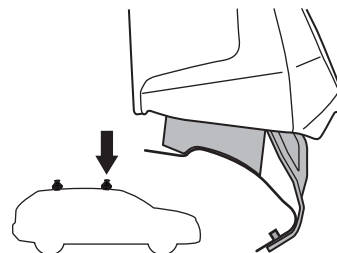
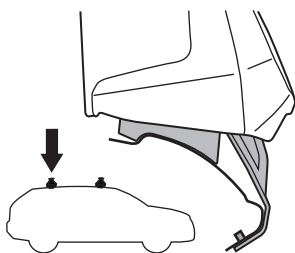
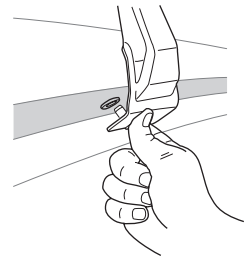
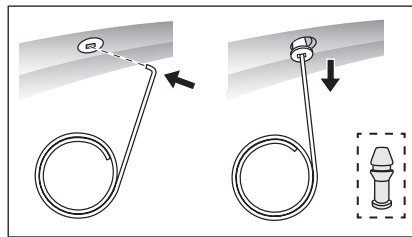
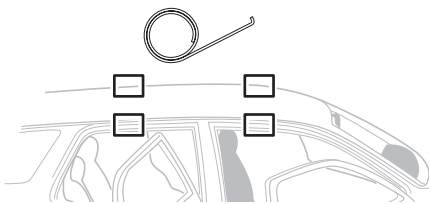
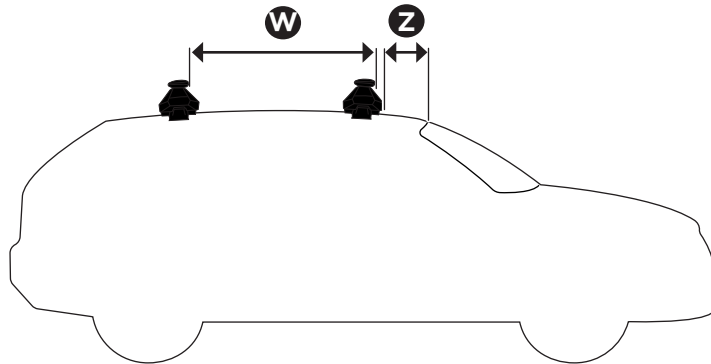

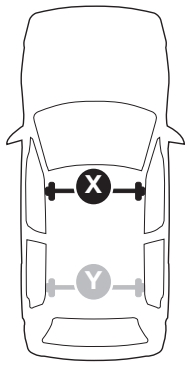

THULE WingBar Evo	THULE WingBar Edge	THULE WingBar	THULE SquareBar Evo	<b>Evo X (scale)</b>	<b>Edge X (scale)</b>
<b>AUDI A4, 4-dr Sedan, 08-15</b>				<b>35,5</b>	<b>H</b>
THULE ProBar Evo	THULE SlideBar Evo				<b>X (mm/inch)</b>
<b>AUDI A4, 4-dr Sedan, 08-15</b>				<b>1006 mm / 39 5/8"</b>	

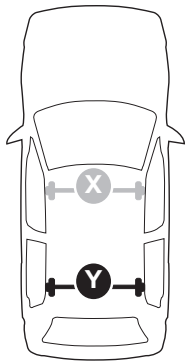

THULE WingBar Evo	THULE WingBar Edge	THULE WingBar	THULE SquareBar Evo	<b>Evo Y (scale)</b>	<b>Edge Y (scale)</b>
<b>AUDI A4, 4-dr Sedan, 08-15</b>				<b>30</b>	<b>A</b>
THULE ProBar Evo	THULE SlideBar Evo				<b>Y (mm/inch)</b>
<b>AUDI A4, 4-dr Sedan, 08-15</b>				<b>951 mm / 37 1/2"</b>	

	<b>W (mm/inch)</b>	<b>Z (mm/inch)</b>
<b>AUDI A4, 4-dr Sedan, 08-15</b>	<b>765 mm / 30 1/8"</b>	<b>205 mm / 8 1/8"</b>

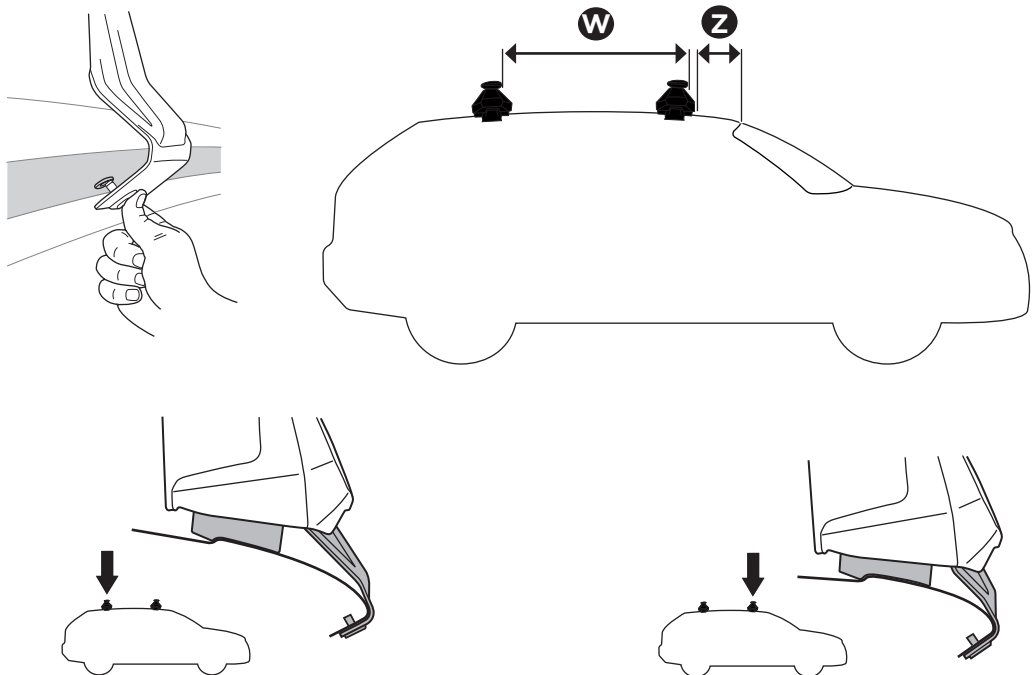

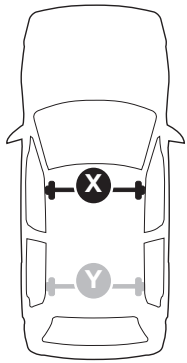

				<b>Evo X (scale)</b>	<b>Edge X (scale)</b>
<b>VOLKSWAGEN Passat CC, 4-dr Coupé, 08-11 / *09-11</b>				46,5	D
<b>VOLKSWAGEN CC, 4-dr Coupé, 12-17</b>				46,5	D
		<b>X (mm/inch)</b>			
<b>VOLKSWAGEN Passat CC, 4-dr Coupé, 08-11 / *09-11</b>				1116 mm / 43 7/8"	
<b>VOLKSWAGEN CC, 4-dr Coupé, 12-17</b>				1116 mm / 43 7/8"	

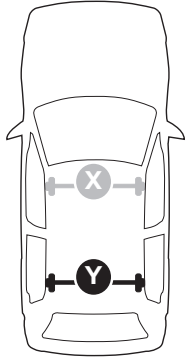

				<b>Evo Y (scale)</b>	<b>Edge Y (scale)</b>
<b>VOLKSWAGEN Passat CC, 4-dr Coupé, 08-11 / *09-11</b>				40	Q
<b>VOLKSWAGEN CC, 4-dr Coupé, 12-17</b>				40	Q
		<b>Y (mm/inch)</b>			
<b>VOLKSWAGEN Passat CC, 4-dr Coupé, 08-11 / *09-11</b>				1051 mm / 41 3/8"	
<b>VOLKSWAGEN CC, 4-dr Coupé, 12-17</b>				1051 mm / 41 3/8"	



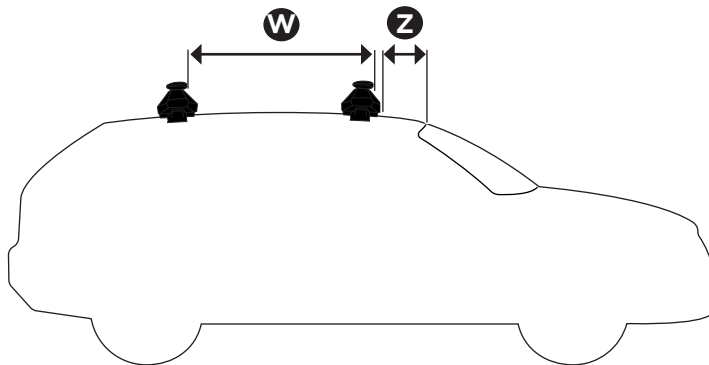

	<b>W (mm/inch)</b>	<b>Z (mm/inch)</b>
<b>VOLKSWAGEN Passat CC, 4-dr Coupé, 08-11 / *09-11</b>	730 mm / 28 3/4"	160 mm / 6 1/4"
<b>VOLKSWAGEN CC, 4-dr Coupé, 12-17</b>	730 mm / 28 3/4"	160 mm / 6 1/4"

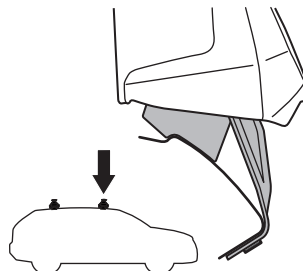
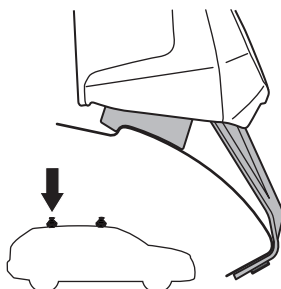
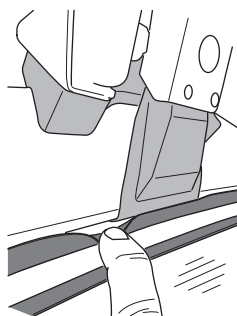
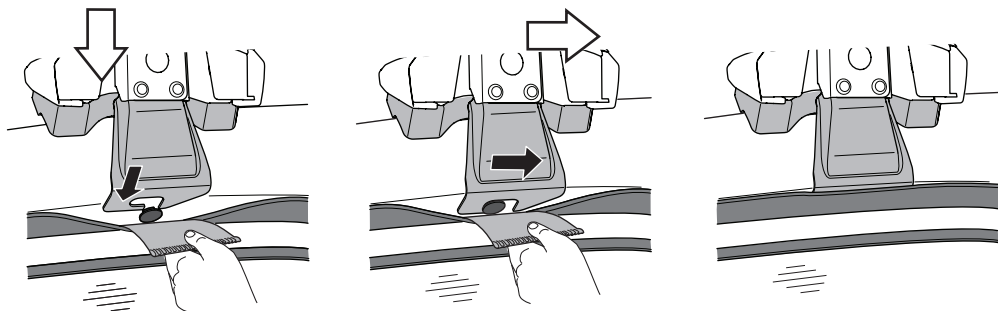

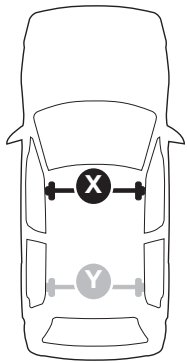

**i**







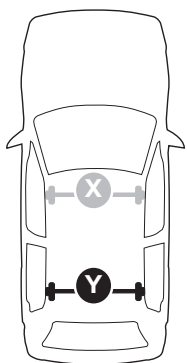

 THULE WingBar Evo  THULE WingBar Edge  THULE WingBar  THULE SquareBar Evo	Evo X (scale)	Edge X (scale)
FORD Fiesta, 5-dr Hatchback, 08-17	36	G
FORD Fiesta, 5-dr Hatchback, *11-	36	G
FORD Fiesta, 4-dr Sedan, *11-	37	E

 THULE ProBar Evo  THULE SlideBar Evo	X (mm/inch)
FORD Fiesta, 5-dr Hatchback, 08-17	1011 mm / 39 3/4"
FORD Fiesta, 5-dr Hatchback, *11-	1011 mm / 39 3/4"
FORD Fiesta, 4-dr Sedan, *11-	1021 mm / 40 1/4"



 THULE WingBar Evo  THULE WingBar Edge  THULE WingBar  THULE SquareBar Evo	Evo Y (scale)	Edge Y (scale)
FORD Fiesta, 5-dr Hatchback, 08-17	30,5	R
FORD Fiesta, 5-dr Hatchback, *11-	30,5	R
FORD Fiesta, 4-dr Sedan, *11-	31.5	P

 THULE ProBar Evo  THULE SlideBar Evo	Y (mm/inch)
FORD Fiesta, 5-dr Hatchback, 08-17	956 mm / 37 5/8"
FORD Fiesta, 5-dr Hatchback, *11-	956 mm / 37 5/8"
FORD Fiesta, 4-dr Sedan, *11-	966 mm / 38"

	W (mm/inch)	Z (mm/inch)
FORD Fiesta, 5-dr Hatchback, 08-17	700 mm / 27 1/2"	200 mm / 7 7/8"
FORD Fiesta, 5-dr Hatchback, *11-	700 mm / 27 1/2"	200 mm / 7 7/8"
FORD Fiesta, 4-dr Sedan, *11-	650 mm / 25 5/8"	200 mm / 7 7/8"

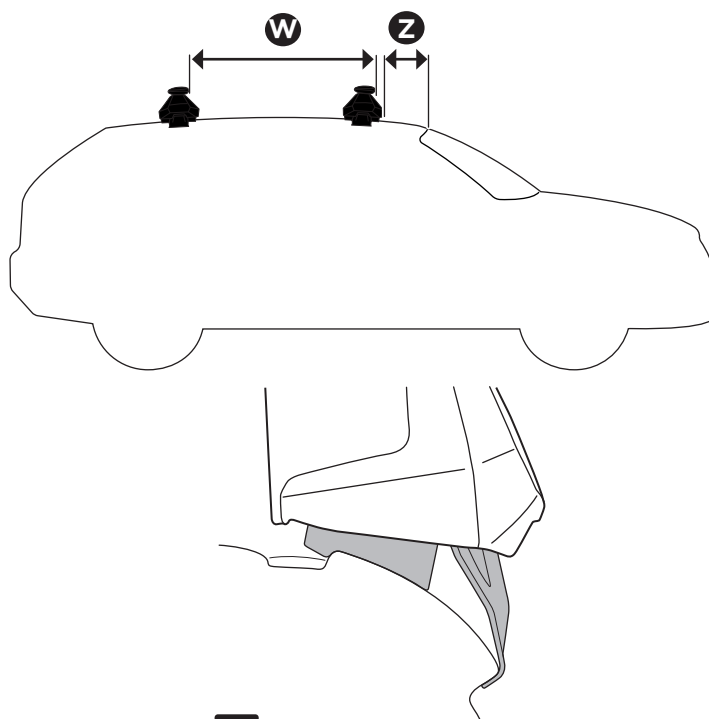

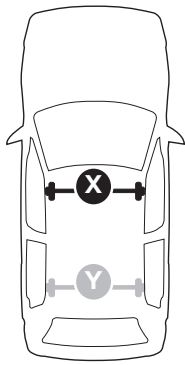

THULE WingBar Evo	THULE WingBar Edge	THULE WingBar	THULE SquareBar Evo	Evo X (scale)	Edge X (scale)
RENAULT Grand Scénic III, 5-dr MPV, 09-16				43	K
RENAULT Scénic III, 5-dr MPV, 09-16				43	K

THULE ProBar Evo	THULE SlideBar Evo	X (mm/inch)
RENAULT Grand Scénic III, 5-dr MPV, 09-16		1081 mm / 42 1/2"
RENAULT Scénic III, 5-dr MPV, 09-16		1081 mm / 42 1/2"

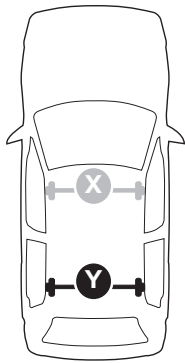

THULE WingBar Evo	THULE WingBar Edge	THULE WingBar	THULE SquareBar Evo	Evo Y (scale)	Edge Y (scale)
RENAULT Grand Scénic III, 5-dr MPV, 09-16				42,5	L
RENAULT Scénic III, 5-dr MPV, 09-16				42,5	L

THULE ProBar Evo	THULE SlideBar Evo	Y (mm/inch)
RENAULT Grand Scénic III, 5-dr MPV, 09-16		1076 mm / 42 3/8"
RENAULT Scénic III, 5-dr MPV, 09-16		1076 mm / 42 3/8"

	W (mm/inch)	Z (mm/inch)
RENAULT Grand Scénic III, 5-dr MPV, 09-16	725 mm / 28 1/2"	260 mm / 10 1/4"
RENAULT Scénic III, 5-dr MPV, 09-16	725 mm / 28 1/2"	260 mm / 10 1/4"

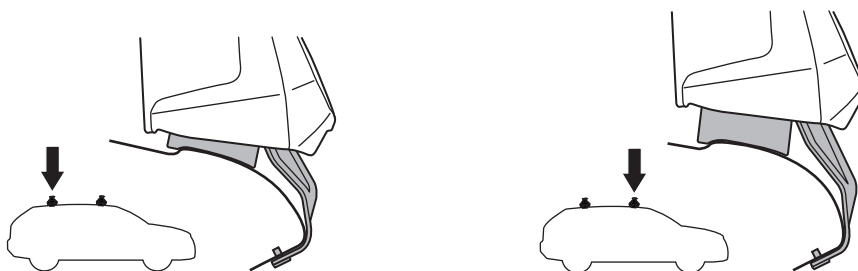
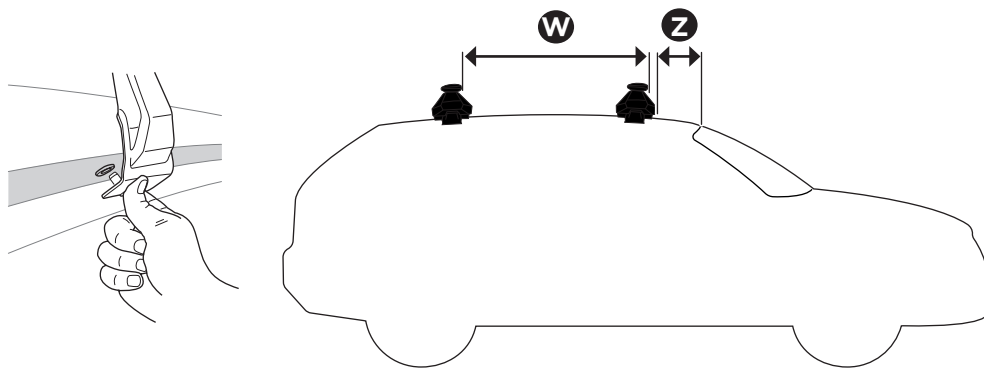

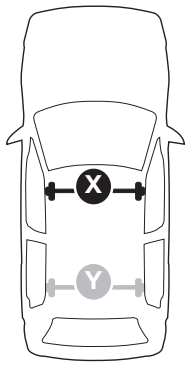

THULE WingBar Evo	THULE WingBar Edge	THULE WingBar	THULE SquareBar Evo	<b>Evo X (scale)</b>	<b>Edge X (scale)</b>
<b>FORD Focus (Mk. III), 5-dr Hatchback, 11-18</b>				<b>39,5</b>	<b>R</b>
THULE ProBar Evo	THULE SlideBar Evo				<b>X (mm/inch)</b>
<b>FORD Focus (Mk. III), 5-dr Hatchback, 11-18</b>				<b>1046 mm / 41 1/8"</b>	

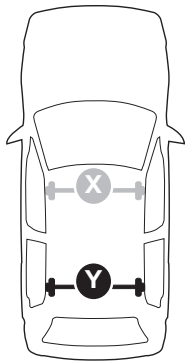

THULE WingBar Evo	THULE WingBar Edge	THULE WingBar	THULE SquareBar Evo	<b>Evo Y (scale)</b>	<b>Edge Y (scale)</b>
<b>FORD Focus (Mk. III), 5-dr Hatchback, 11-18</b>				<b>34</b>	<b>K</b>
THULE ProBar Evo	THULE SlideBar Evo				<b>Y (mm/inch)</b>
<b>FORD Focus (Mk. III), 5-dr Hatchback, 11-18</b>				<b>991 mm / 39"</b>	

	<b>W (mm/inch)</b>	<b>Z (mm/inch)</b>
<b>FORD Focus (Mk. III), 5-dr Hatchback, 11-18</b>	<b>785 mm / 30 9/16"</b>	<b>250 mm / 9 7/8"</b>

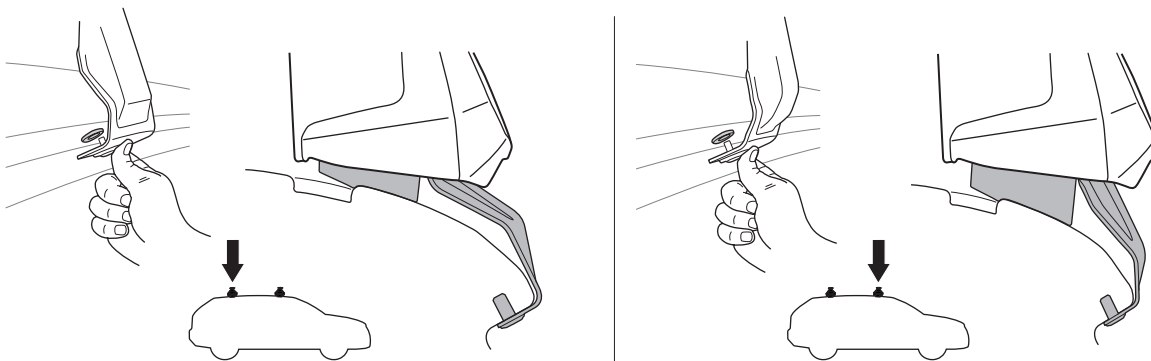
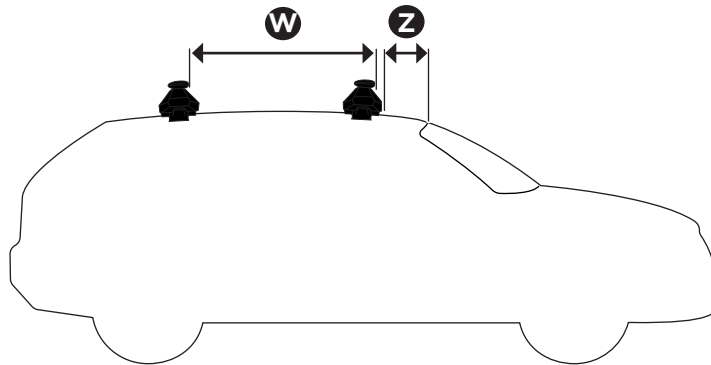

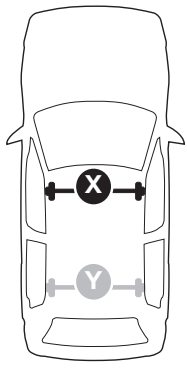

THULE WingBar Evo	THULE WingBar Edge	THULE WingBar	THULE SquareBar Evo	<b>Evo X (scale)</b>	<b>Edge X (scale)</b>
<b>VOLVO V40, 5-dr Hatchback, 12-</b>				<b>39,5</b>	<b>R</b>
THULE ProBar Evo	THULE SlideBar Evo				<b>X (mm/inch)</b>
<b>VOLVO V40, 5-dr Hatchback, 12-</b>				<b>1046 mm / 41 1/8"</b>	

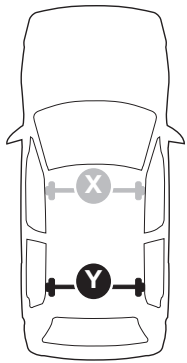

THULE WingBar Evo	THULE WingBar Edge	THULE WingBar	THULE SquareBar Evo	<b>Evo Y (scale)</b>	<b>Edge Y (scale)</b>
<b>VOLVO V40, 5-dr Hatchback, 12-</b>				<b>27</b>	<b>G</b>
THULE ProBar Evo	THULE SlideBar Evo				<b>Y (mm/inch)</b>
<b>VOLVO V40, 5-dr Hatchback, 12-</b>				<b>921 mm / 36 1/4"</b>	

	<b>W (mm/inch)</b>	<b>Z (mm/inch)</b>
<b>VOLVO V40, 5-dr Hatchback, 12-</b>	<b>770 mm / 30 3/8"</b>	<b>225 mm / 8 7/8"</b>

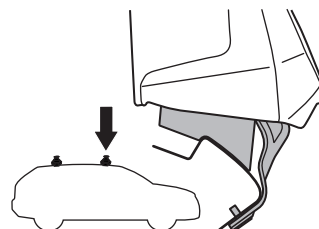
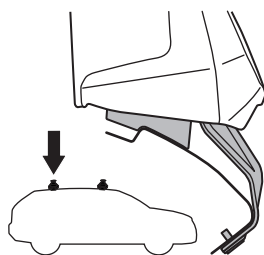
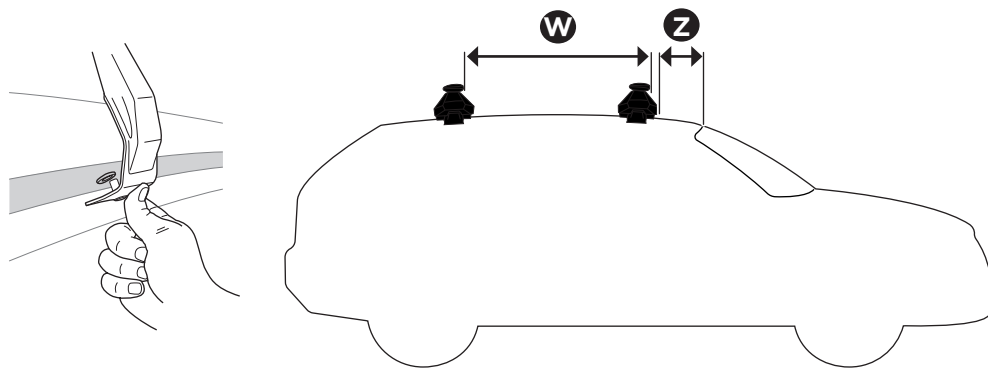

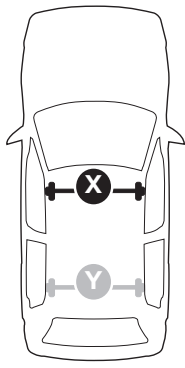

THULE WingBar Evo	THULE WingBar Edge	THULE WingBar	THULE SquareBar Evo	<b>Evo X (scale)</b>	<b>Edge X (scale)</b>
<b>TOYOTA Hilux, 4-dr Double Cab, 05-15</b>				<b>45,5</b>	<b>F</b>
<b>TOYOTA Vigo, 4-dr Double Cab, 04-15</b>				<b>45,5</b>	<b>F</b>

THULE ProBar Evo	THULE SlideBar Evo			<b>X (mm/inch)</b>	
<b>TOYOTA Hilux, 4-dr Double Cab, 05-15</b>				<b>1106 mm / 43 1/2"</b>	
<b>TOYOTA Vigo, 4-dr Double Cab, 04-15</b>				<b>1106 mm / 43 1/2"</b>	

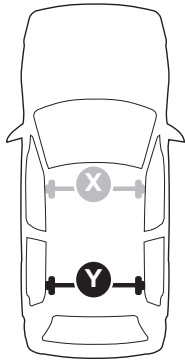

THULE WingBar Evo	THULE WingBar Edge	THULE WingBar	THULE SquareBar Evo	<b>Evo Y (scale)</b>	<b>Edge Y (scale)</b>
<b>TOYOTA Hilux, 4-dr Double Cab, 05-15</b>				<b>44,5</b>	<b>H</b>
<b>TOYOTA Vigo, 4-dr Double Cab, 04-15</b>				<b>44,5</b>	<b>H</b>

THULE ProBar Evo	THULE SlideBar Evo			<b>Y (mm/inch)</b>	
<b>TOYOTA Hilux, 4-dr Double Cab, 05-15</b>				<b>1096 mm / 43 1/8"</b>	
<b>TOYOTA Vigo, 4-dr Double Cab, 04-15</b>				<b>1096 mm / 43 1/8"</b>	

	<b>W (mm/inch)</b>	<b>Z (mm/inch)</b>
<b>TOYOTA Hilux, 4-dr Double Cab, 05-15</b>	<b>710 mm / 28"</b>	<b>245 mm / 9 5/8"</b>
<b>TOYOTA Vigo, 4-dr Double Cab, 04-15</b>	<b>710 mm / 28"</b>	<b>245 mm / 9 5/8"</b>

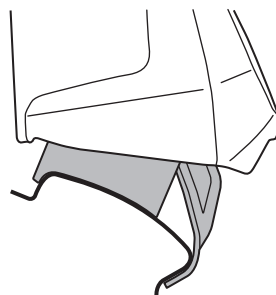
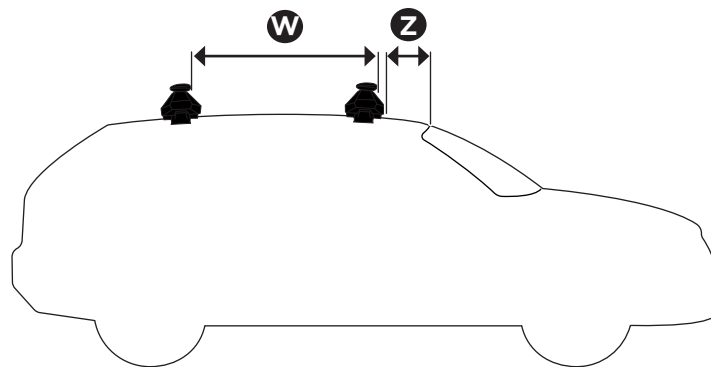



THULE WingBar Evo	THULE WingBar Edge	THULE WingBar	THULE SquareBar Evo	Evo X (scale)	Edge X (scale)
HOLDEN/OPEL/VAUXHALL Insignia, 4-dr Sedan, 08-17				45	G
HOLDEN/OPEL/VAUXHALL Insignia, 5-dr Hatchback, 08-17				45,5	F

THULE ProBar Evo	THULE SlideBar Evo	X (mm/inch)
HOLDEN/OPEL/VAUXHALL Insignia, 4-dr Sedan, 08-17		1101 mm / 43 <sup>3</sup> / <sub>8</sub> "
HOLDEN/OPEL/VAUXHALL Insignia, 5-dr Hatchback, 08-17		1106 mm / 43 <sup>1</sup> / <sub>2</sub> "

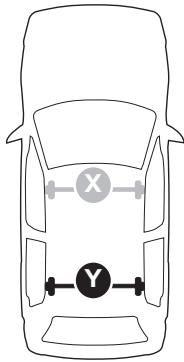

THULE WingBar Evo	THULE WingBar Edge	THULE WingBar	THULE SquareBar Evo	Evo Y (scale)	Edge Y (scale)
HOLDEN/OPEL/VAUXHALL Insignia, 4-dr Sedan, 08-17				37,5	D
HOLDEN/OPEL/VAUXHALL Insignia, 5-dr Hatchback, 08-17				38,5	B

THULE ProBar Evo	THULE SlideBar Evo	Y (mm/inch)
HOLDEN/OPEL/VAUXHALL Insignia, 4-dr Sedan, 08-17		1026 mm / 40 <sup>3</sup> / <sub>8</sub> "
HOLDEN/OPEL/VAUXHALL Insignia, 5-dr Hatchback, 08-17		1036 mm / 40 <sup>3</sup> / <sub>4</sub> "

	W (mm/inch)	Z (mm/inch)
HOLDEN/OPEL/VAUXHALL Insignia, 4-dr Sedan, 08-17	740 mm / 29 <sup>1</sup> / <sub>8</sub> "	130 mm / 5 <sup>1</sup> / <sub>8</sub> "
HOLDEN/OPEL/VAUXHALL Insignia, 5-dr Hatchback, 08-17	735 mm / 28 <sup>7</sup> / <sub>8</sub> "	125 mm / 4 <sup>7</sup> / <sub>8</sub> "

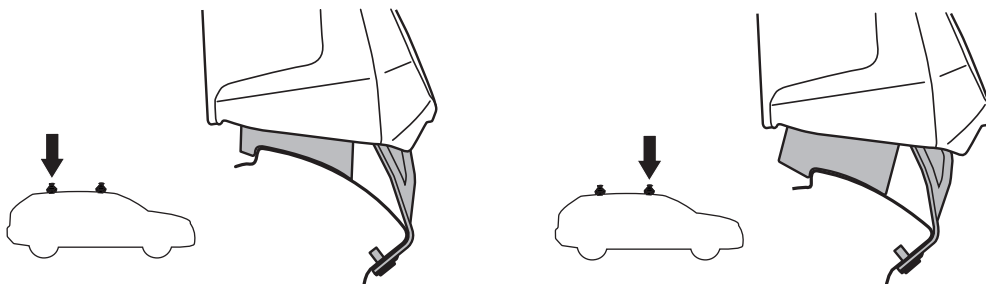
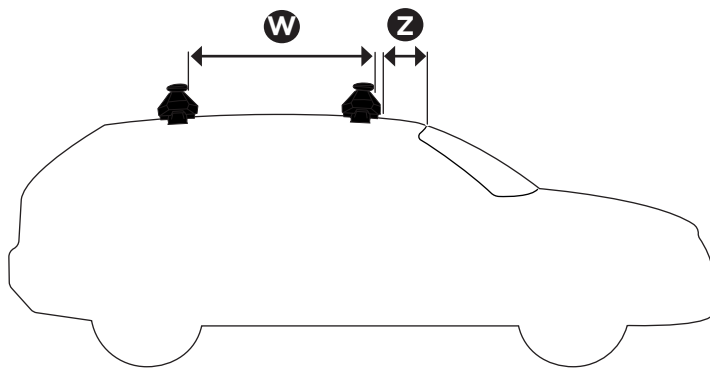

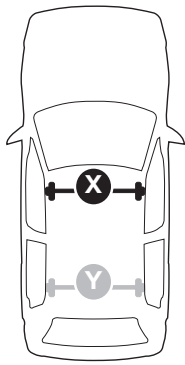

THULE WingBar Evo	THULE WingBar Edge	THULE WingBar	THULE SquareBar Evo	<b>Evo X (scale)</b>	<b>Edge X (scale)</b>
<b>VOLKSWAGEN Passat, 4-dr Sedan, 05-09, 10-14 / *06-10</b>				<b>43,5</b>	<b>J</b>
THULE ProBar Evo	THULE SlideBar Evo				<b>X (mm/inch)</b>
<b>VOLKSWAGEN Passat, 4-dr Sedan, 05-09, 10-14 / *06-10</b>				<b>1086 mm / 42 3/4"</b>	

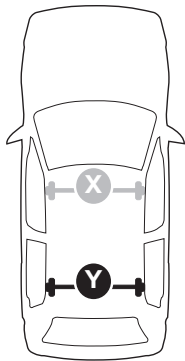

THULE WingBar Evo	THULE WingBar Edge	THULE WingBar	THULE SquareBar Evo	<b>Evo Y (scale)</b>	<b>Edge Y (scale)</b>
<b>VOLKSWAGEN Passat, 4-dr Sedan, 05-09, 10-14 / *06-10</b>				<b>41,5</b>	<b>N</b>
THULE ProBar Evo	THULE SlideBar Evo				<b>Y (mm/inch)</b>
<b>VOLKSWAGEN Passat, 4-dr Sedan, 05-09, 10-14 / *06-10</b>				<b>1066 mm / 42"</b>	

	<b>W (mm/inch)</b>	<b>Z (mm/inch)</b>
<b>VOLKSWAGEN Passat, 4-dr Sedan, 05-09, 10-14 / *06-10</b>	<b>785 mm / 30 7/8"</b>	<b>265 mm / 10 3/8"</b>

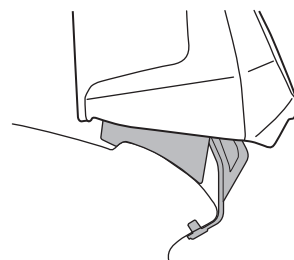
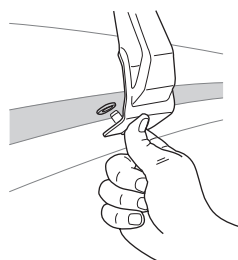
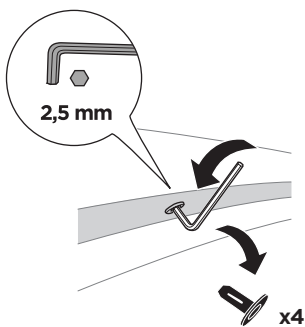
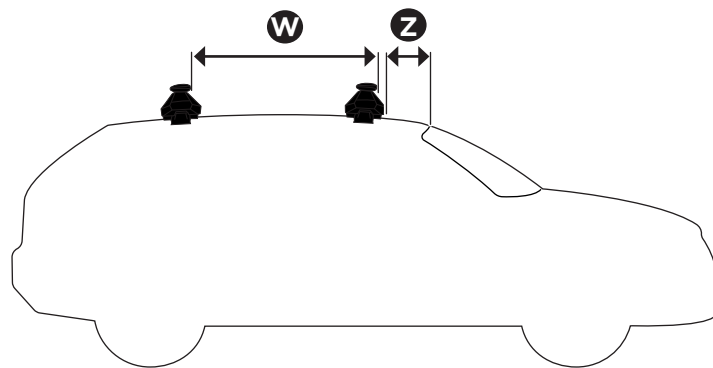

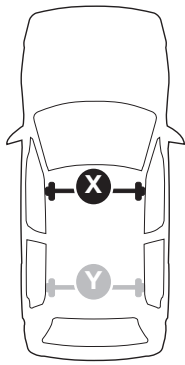

THULE WingBar Evo	THULE WingBar Edge	THULE WingBar	THULE SquareBar Evo	<b>Evo X (scale)</b>	<b>Edge X (scale)</b>
<b>SKODA Octavia II, 4-dr Sedan, 04-08, 09-12</b>				<b>33,5</b>	<b>L</b>

THULE ProBar Evo	THULE SlideBar Evo	<b>X (mm/inch)</b>		
<b>SKODA Octavia II, 4-dr Sedan, 04-08, 09-12</b>		<b>986 mm / 37 7/8"</b>		

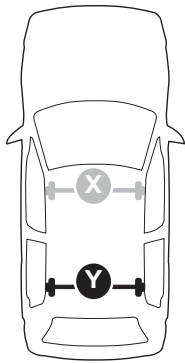

THULE WingBar Evo	THULE WingBar Edge	THULE WingBar	THULE SquareBar Evo	<b>Evo Y (scale)</b>	<b>Edge Y (scale)</b>
<b>SKODA Octavia II, 4-dr Sedan, 04-08, 09-12</b>				<b>29</b>	<b>C</b>

THULE ProBar Evo	THULE SlideBar Evo	<b>Y (mm/inch)</b>		
<b>SKODA Octavia II, 4-dr Sedan, 04-08, 09-12</b>		<b>941 mm / 37"</b>		

	<b>W (mm/inch)</b>	<b>Z (mm/inch)</b>
<b>SKODA Octavia II, 4-dr Sedan, 04-08, 09-12</b>	<b>830 mm / 32 5/8"</b>	<b>230 mm / 9"</b>

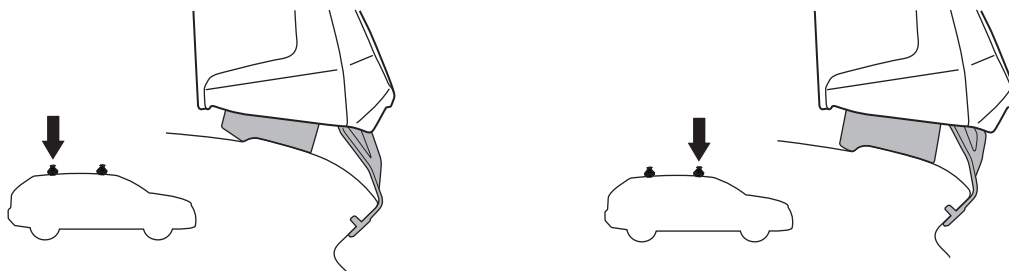
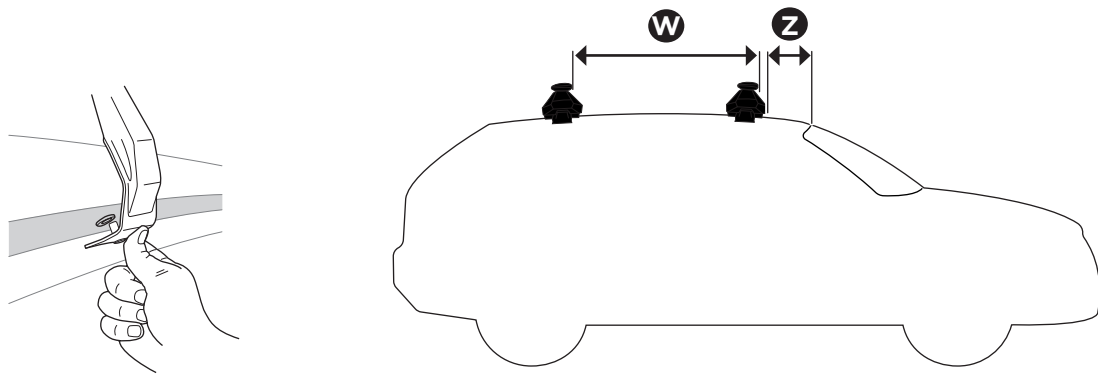

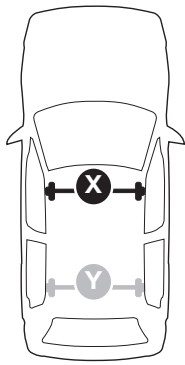

THULE WingBar Evo	THULE WingBar Edge	THULE WingBar	THULE SquareBar Evo	<b>Evo X (scale)</b>	<b>Edge X (scale)</b>
<b>NISSAN Juke, 5-dr SUV, 10-19</b>				<b>34</b>	<b>K</b>

THULE ProBar Evo	THULE SlideBar Evo	<b>X (mm/inch)</b>		
<b>NISSAN Juke, 5-dr SUV, 10-19</b>		<b>991 mm / 39"</b>		

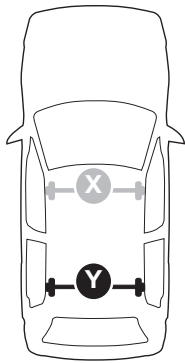

THULE WingBar Evo	THULE WingBar Edge	THULE WingBar	THULE SquareBar Evo	<b>Evo Y (scale)</b>	<b>Edge Y (scale)</b>
<b>NISSAN Juke, 5-dr SUV, 10-19</b>				<b>31,5</b>	<b>P</b>

THULE ProBar Evo	THULE SlideBar Evo	<b>Y (mm/inch)</b>		
<b>NISSAN Juke, 5-dr SUV, 10-19</b>		<b>966 mm / 38"</b>		

	<b>W (mm/inch)</b>	<b>Z (mm/inch)</b>
<b>NISSAN Juke, 5-dr SUV, 10-19</b>	<b>700 mm / 27 1/2"</b>	<b>250 mm / 9 7/8"</b>

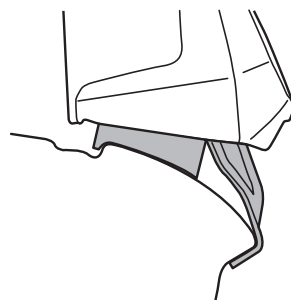
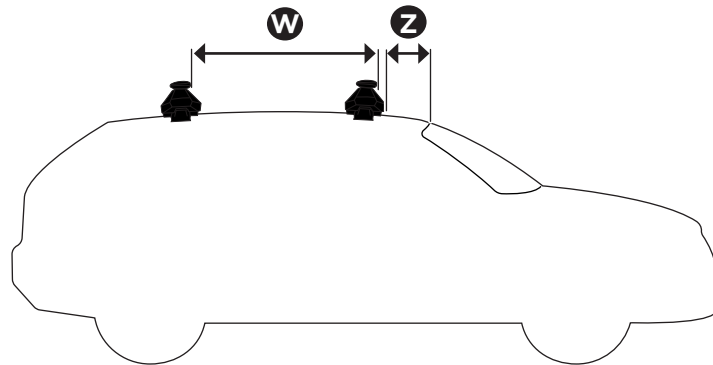

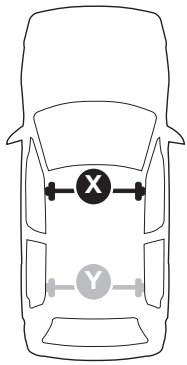

THULE WingBar Evo	THULE WingBar Edge	THULE WingBar	THULE SquareBar Evo	<b>Evo X (scale)</b>	<b>Edge X (scale)</b>
<b>TOYOTA Corolla Verso III, 5-dr MPV, 04-08</b>				<b>49</b>	<b>Q</b>

THULE ProBar Evo	THULE SlideBar Evo	<b>X (mm/inch)</b>		
<b>TOYOTA Corolla Verso III, 5-dr MPV, 04-08</b>		<b>1141 mm / 44 7/8"</b>		

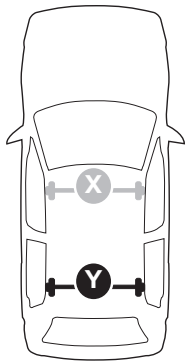

THULE WingBar Evo	THULE WingBar Edge	THULE WingBar	THULE SquareBar Evo	<b>Evo Y (scale)</b>	<b>Edge Y (scale)</b>
<b>TOYOTA Corolla Verso III, 5-dr MPV, 04-08</b>				<b>42</b>	<b>M</b>

THULE ProBar Evo	THULE SlideBar Evo	<b>Y (mm/inch)</b>		
<b>TOYOTA Corolla Verso III, 5-dr MPV, 04-08</b>		<b>1071 mm / 42 1/8"</b>		

	<b>W (mm/inch)</b>	<b>Z (mm/inch)</b>
<b>TOYOTA Corolla Verso III, 5-dr MPV, 04-08</b>	<b>720 mm / 28 3/8"</b>	<b>345 mm / 13 5/8"</b>

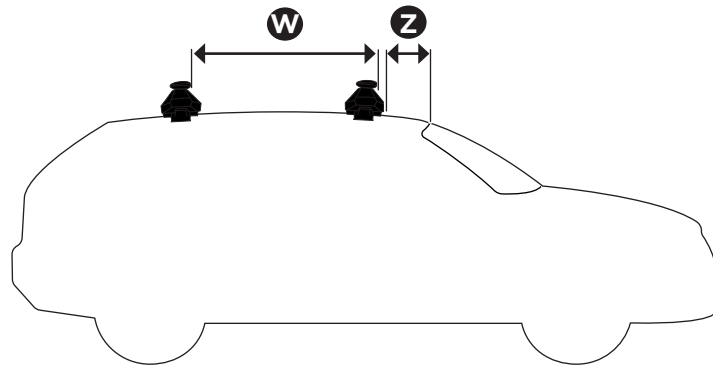

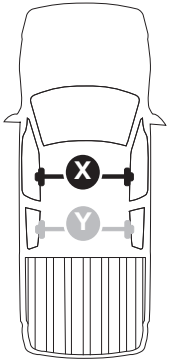

THULE WingBar Evo	THULE WingBar Edge	THULE WingBar	THULE SquareBar Evo	Evo X (scale)	Edge X (scale)
MITSUBISHI L200, 4-dr Double Cab, 05-15				40,5	P
MITSUBISHI Triton, 4-dr Double Cab, 05-15				40,5	P

THULE ProBar Evo	THULE SlideBar Evo	X (mm/inch)
MITSUBISHI L200, 4-dr Double Cab, 05-15		1056 mm / 41 5/8"
MITSUBISHI Triton, 4-dr Double Cab, 05-15		1056 mm / 41 5/8"

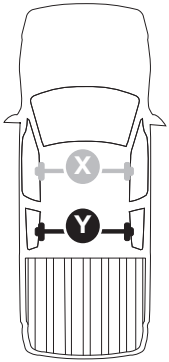

THULE WingBar Evo	THULE WingBar Edge	THULE WingBar	THULE SquareBar Evo	Evo Y (scale)	Edge Y (scale)
MITSUBISHI L200, 4-dr Double Cab, 05-15				33,5	L
MITSUBISHI Triton, 4-dr Double Cab, 05-15				33,5	L

THULE ProBar Evo	THULE SlideBar Evo	Y (mm/inch)
MITSUBISHI L200, 4-dr Double Cab, 05-15		986 mm / 38 7/8"
MITSUBISHI Triton, 4-dr Double Cab, 05-15		986 mm / 38 7/8"

	W (mm/inch)	Z (mm/inch)
MITSUBISHI L200, 4-dr Double Cab, 05-15	800 mm / 31 1/2"	350 mm / 13 3/4"
MITSUBISHI Triton, 4-dr Double Cab, 05-15	800 mm / 31 1/2"	350 mm / 13 3/4"



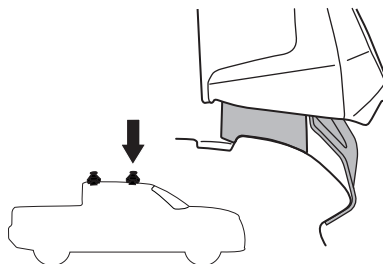
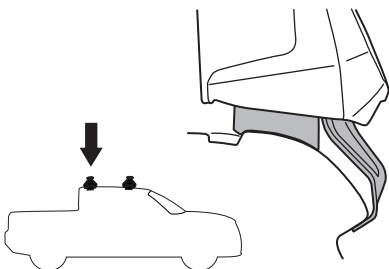
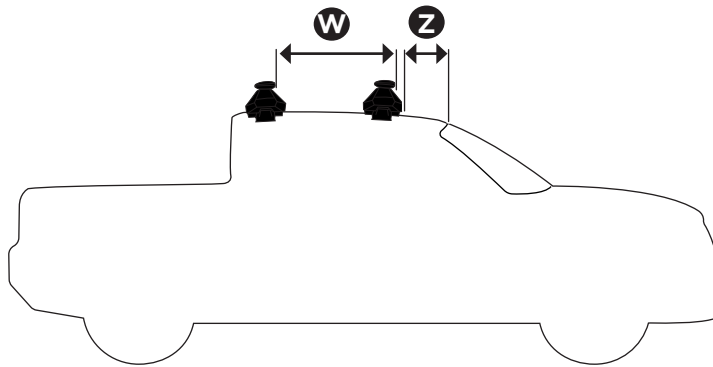

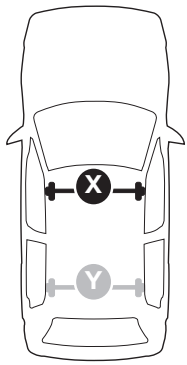
THULE WingBar Evo	THULE WingBar Edge	THULE WingBar	THULE SquareBar Evo	<b>Evo X (scale)</b>	<b>Edge X (scale)</b>
<b>BMW X4, 5-dr SUV, 15-18</b>				<b>48,5</b>	<b>R</b>

THULE ProBar Evo	THULE SlideBar Evo	<b>X (mm/inch)</b>		
<b>BMW X4, 5-dr SUV, 15-18</b>		<b>1136 mm / 44 3/4"</b>		

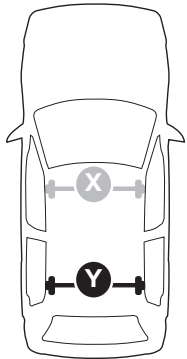

THULE WingBar Evo	THULE WingBar Edge	THULE WingBar	THULE SquareBar Evo	<b>Evo Y (scale)</b>	<b>Edge Y (scale)</b>
<b>BMW X4, 5-dr SUV, 15-18</b>				<b>46,5</b>	<b>D</b>

THULE ProBar Evo	THULE SlideBar Evo	<b>Y (mm/inch)</b>		
<b>BMW X4, 5-dr SUV, 15-18</b>		<b>1116 mm / 43 7/8"</b>		

	<b>W (mm/inch)</b>	<b>Z (mm/inch)</b>
<b>BMW X4, 5-dr SUV, 15-18</b>	<b>700 mm / 27 1/2"</b>	<b>265 mm / 10 3/8"</b>

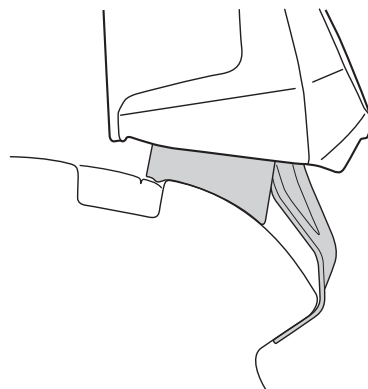
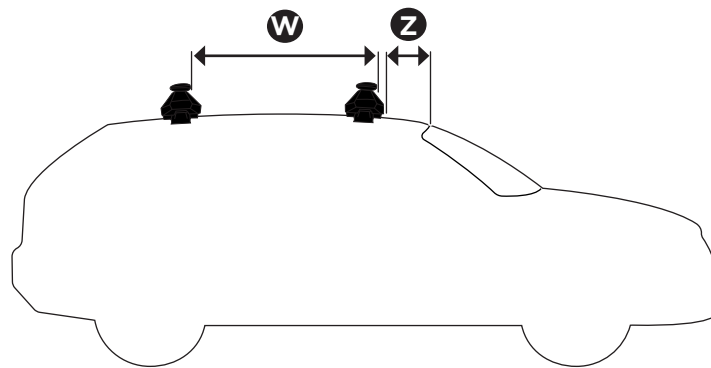

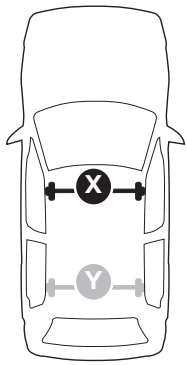

THULE WingBar Evo	THULE WingBar Edge	THULE WingBar	THULE SquareBar Evo	Evo X (scale)	Edge X (scale)
RENAULT Mégane (Mk. III), 5-dr Estate 09-16				41	0
RENAULT Mégane (Mk. III), 5-dr Hatchback, 09-16				41	0

THULE ProBar Evo	THULE SlideBar Evo	X (mm/inch)
RENAULT Mégane (Mk. III), 5-dr Estate 09-16		1061 mm / 41 3/4"
RENAULT Mégane (Mk. III), 5-dr Hatchback, 09-16		1061 mm / 41 3/4"

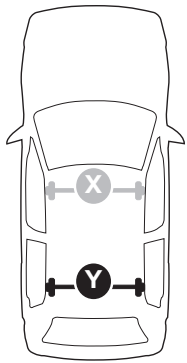

THULE WingBar Evo	THULE WingBar Edge	THULE WingBar	THULE SquareBar Evo	Evo Y (scale)	Edge Y (scale)
RENAULT Mégane (Mk. III), 5-dr Estate 09-16				36,5	F
RENAULT Mégane (Mk. III), 5-dr Hatchback, 09-16				36,5	F

THULE ProBar Evo	THULE SlideBar Evo	Y (mm/inch)
RENAULT Mégane (Mk. III), 5-dr Estate 09-16		1016 mm / 40"
RENAULT Mégane (Mk. III), 5-dr Hatchback, 09-16		1016 mm / 40"

	W (mm/inch)	Z (mm/inch)
RENAULT Mégane (Mk. III), 5-dr Estate 09-16	730 mm / 28 3/4"	115 mm / 4 1/2"
RENAULT Mégane (Mk. III), 5-dr Hatchback, 09-16	730 mm / 28 3/4"	115 mm / 4 1/2"



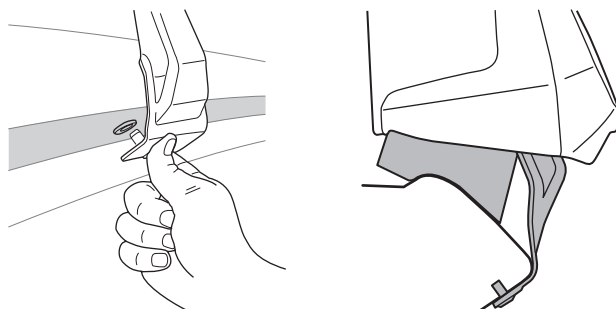
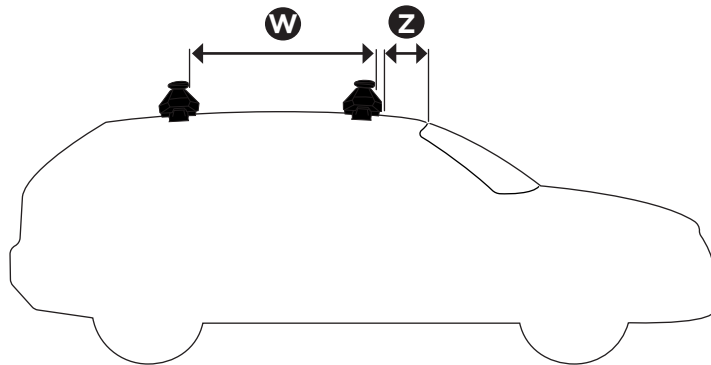

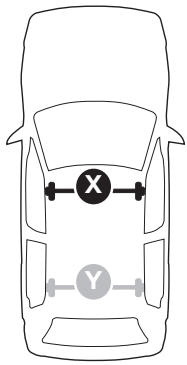
THULE WingBar Evo	THULE WingBar Edge	THULE WingBar	THULE SquareBar Evo	<b>Evo X (scale)</b>	<b>Edge X (scale)</b>
<b>BMW X6, 5-dr SUV, 15-</b>				<b>45,5</b>	<b>F</b>
THULE ProBar Evo	THULE SlideBar Evo				<b>X (mm/inch)</b>
<b>BMW X6, 5-dr SUV, 15-</b>				<b>1106 mm / 43 1/2"</b>	

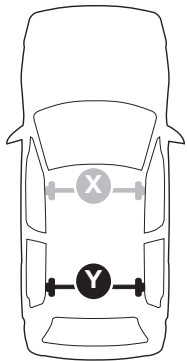





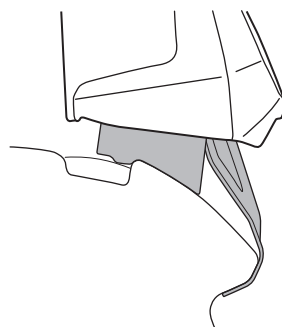
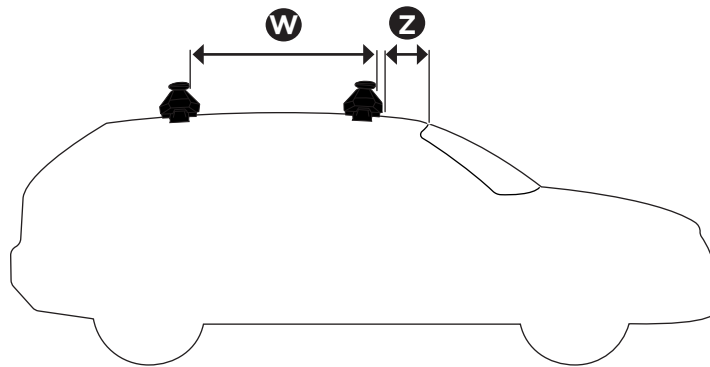

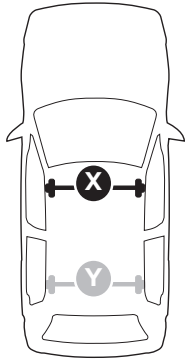
THULE WingBar Evo	THULE WingBar Edge	THULE WingBar	THULE SquareBar Evo	<b>Evo Y (scale)</b>	<b>Edge Y (scale)</b>
<b>BMW X6, 5-dr SUV, 15-</b>				<b>43,5</b>	<b>J</b>
THULE ProBar Evo	THULE SlideBar Evo				<b>Y (mm/inch)</b>
<b>BMW X6, 5-dr SUV, 15-</b>				<b>1086 mm / 42 3/4"</b>	

	<b>W (mm/inch)</b>	<b>Z (mm/inch)</b>
<b>BMW X6, 5-dr SUV, 15-</b>	<b>700 mm / 27 1/2"</b>	<b>180 mm / 7 1/8"</b>









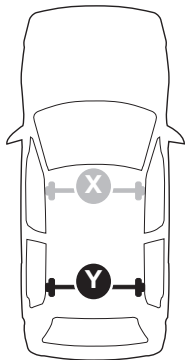

 THULE WingBar Evo  THULE WingBar Edge  THULE WingBar  THULE SquareBar Evo	Evo X (scale)	Edge X (scale)
<b>HOLDEN Astra</b> , 5-dr Hatchback, 16-	39	A
<b>OPEL Astra</b> , 5-dr Hatchback, 16-	39	A
<b>VAUXHALL Astra</b> , 5-dr Hatchback, 16-	39	A

 THULE ProBar Evo  THULE SlideBar Evo	X (mm/inch)
<b>HOLDEN Astra</b> , 5-dr Hatchback, 16-	1041 mm / 41"
<b>OPEL Astra</b> , 5-dr Hatchback, 16-	1041 mm / 41"
<b>VAUXHALL Astra</b> , 5-dr Hatchback, 16-	1041 mm / 41"



 THULE WingBar Evo  THULE WingBar Edge  THULE WingBar  THULE SquareBar Evo	Evo Y (scale)	Edge Y (scale)
<b>HOLDEN Astra</b> , 5-dr Hatchback, 16-	34.5	J
<b>OPEL Astra</b> , 5-dr Hatchback, 16-	34.5	J
<b>VAUXHALL Astra</b> , 5-dr Hatchback, 16-	34.5	J

 THULE ProBar Evo  THULE SlideBar Evo	Y (mm/inch)
<b>HOLDEN Astra</b> , 5-dr Hatchback, 16-	996 mm / 39 1/4"
<b>OPEL Astra</b> , 5-dr Hatchback, 16-	996 mm / 39 1/4"
<b>VAUXHALL Astra</b> , 5-dr Hatchback, 16-	996 mm / 39 1/4"

	W (mm/inch)	Z (mm/inch)
<b>HOLDEN Astra</b> , 5-dr Hatchback, 16-	725 mm / 28 1/2"	225 mm / 8 7/8"
<b>OPEL Astra</b> , 5-dr Hatchback, 16-	725 mm / 28 1/2"	225 mm / 8 7/8"
<b>VAUXHALL Astra</b> , 5-dr Hatchback, 16-	725 mm / 28 1/2"	225 mm / 8 7/8"

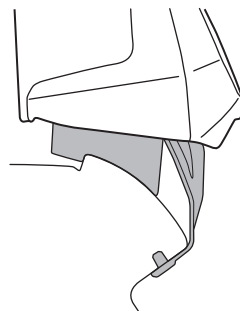
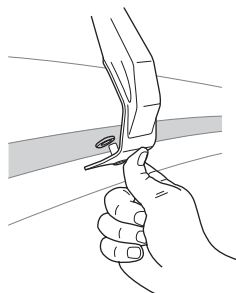
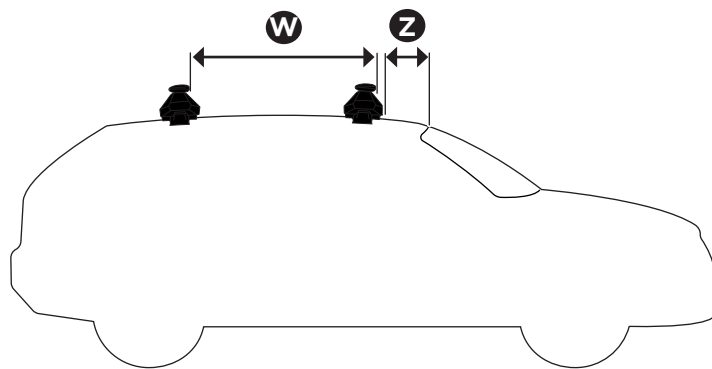

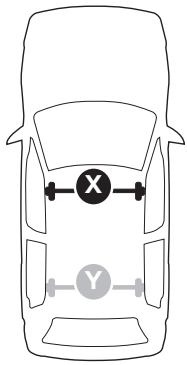

THULE WingBar Evo	THULE WingBar Edge	THULE WingBar	THULE SquareBar Evo	<b>Evo X (scale)</b>	<b>Edge X (scale)</b>
<b>PORSCHE Cayenne, 5-dr SUV, 10-17 (Without railing)</b>				<b>51,5</b>	<b>L</b>
THULE ProBar Evo	THULE SlideBar Evo				<b>X (mm/inch)</b>
<b>PORSCHE Cayenne, 5-dr SUV, 10-17 (Without railing)</b>				<b>1166 mm / 45 7/8"</b>	

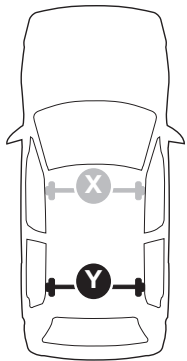

THULE WingBar Evo	THULE WingBar Edge	THULE WingBar	THULE SquareBar Evo	<b>Evo Y (scale)</b>	<b>Edge Y (scale)</b>
<b>PORSCHE Cayenne, 5-dr SUV, 10-17 (Without railing)</b>				<b>46</b>	<b>E</b>
THULE ProBar Evo	THULE SlideBar Evo				<b>Y (mm/inch)</b>
<b>PORSCHE Cayenne, 5-dr SUV, 10-17 (Without railing)</b>				<b>1111 mm / 43 3/4"</b>	

	<b>W (mm/inch)</b>	<b>Z (mm/inch)</b>
<b>PORSCHE Cayenne, 5-dr SUV, 10-17 (Without railing)</b>	<b>700 mm / 27 1/2"</b>	<b>400 mm / 15 3/4"</b>

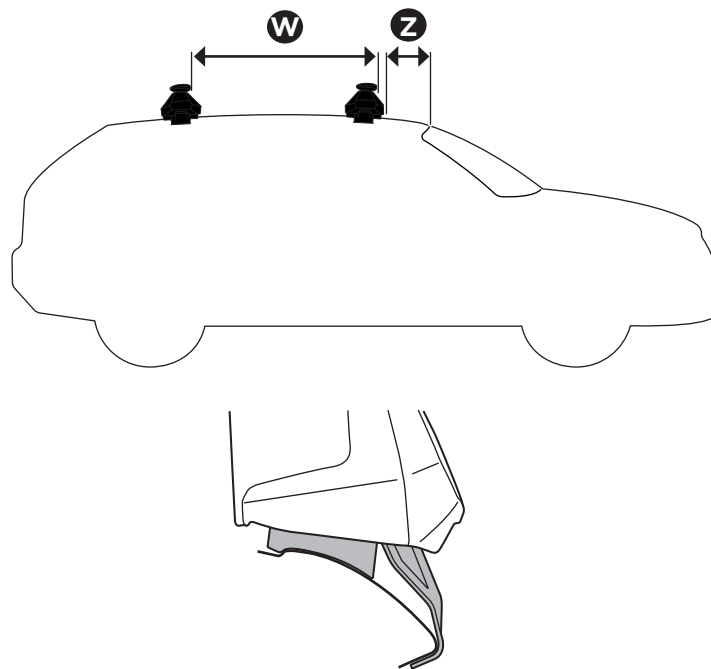

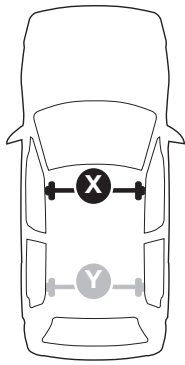

THULE WingBar Evo	THULE WingBar Edge	THULE WingBar	THULE SquareBar Evo	Evo X (scale)	Edge X (scale)
SUBARU Impreza, 4-dr Sedan, 11-16 / *12-17				43,5	J
SUBARU WRX, 4-dr Sedan, 14-17				43,5	J

THULE ProBar Evo	THULE SlideBar Evo	X (mm/inch)
SUBARU Impreza, 4-dr Sedan, 11-16 / *12-17		1086 mm / 42 3/4"
SUBARU WRX, 4-dr Sedan, 14-17		1086 mm / 42 3/4"

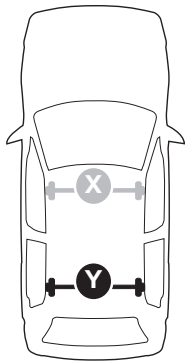

THULE WingBar Evo	THULE WingBar Edge	THULE WingBar	THULE SquareBar Evo	Evo Y (scale)	Edge Y (scale)
SUBARU Impreza, 4-dr Sedan, 11-16 / *12-17				37,5	D
SUBARU WRX, 4-dr Sedan, 14-17				37,5	D

THULE ProBar Evo	THULE SlideBar Evo	Y (mm/inch)
SUBARU Impreza, 4-dr Sedan, 11-16 / *12-17		1026 mm / 40 3/8"
SUBARU WRX, 4-dr Sedan, 14-17		1026 mm / 40 3/8"

	W (mm/inch)	Z (mm/inch)
SUBARU Impreza, 4-dr Sedan, 11-16 / *12-17	700 mm / 27 1/2"	240 mm / 9 1/2"
SUBARU WRX, 4-dr Sedan, 14-17	700 mm / 27 1/2"	240 mm / 9 1/2"

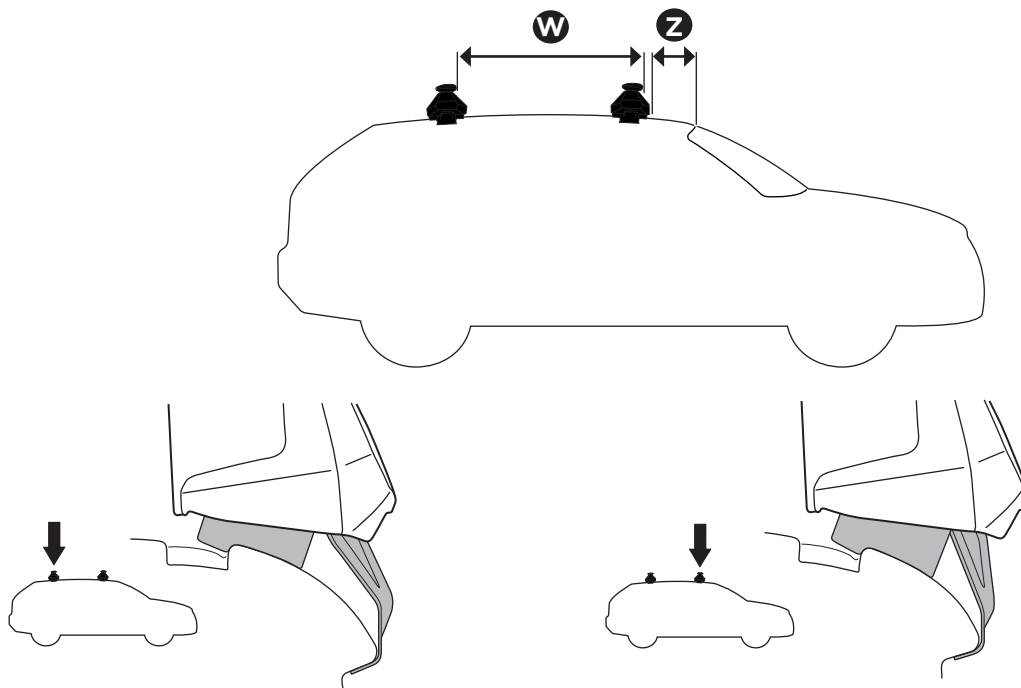

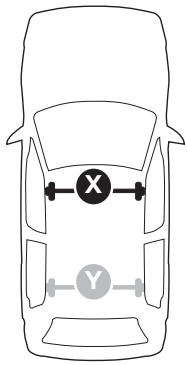

THULE WingBar Evo	THULE WingBar Edge	THULE WingBar	THULE SquareBar Evo	<b>Evo X (scale)</b>	<b>Edge X (scale)</b>
<b>AUDI A6, 4-dr Sedan, 19-</b>				<b>42</b>	<b>M</b>

THULE ProBar Evo	THULE SlideBar Evo	<b>X (mm/inch)</b>		
<b>AUDI A6, 4-dr Sedan, 19-</b>		<b>1071 mm / 42 1/8"</b>		

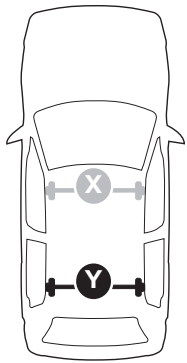

THULE WingBar Evo	THULE WingBar Edge	THULE WingBar	THULE SquareBar Evo	<b>Evo Y (scale)</b>	<b>Edge Y (scale)</b>
<b>AUDI A6, 4-dr Sedan, 19-</b>				<b>41</b>	<b>O</b>

THULE ProBar Evo	THULE SlideBar Evo	<b>Y (mm/inch)</b>		
<b>AUDI A6, 4-dr Sedan, 19-</b>		<b>1061 mm / 41 3/4"</b>		

	<b>W (mm/inch)</b>	<b>Z (mm/inch)</b>
<b>AUDI A6, 4-dr Sedan, 19-</b>	<b>740 mm / 29 1/8"</b>	<b>235 mm / 9 1/4"</b>

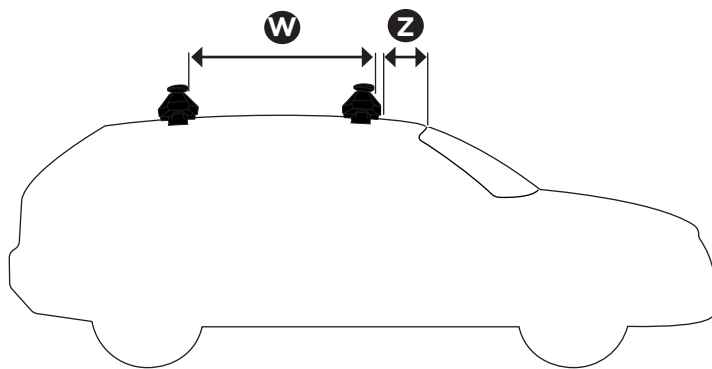
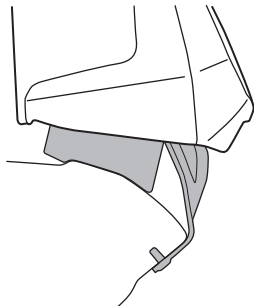
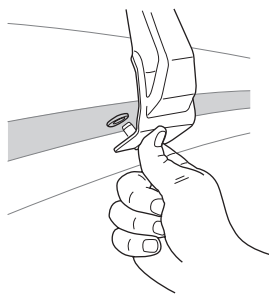

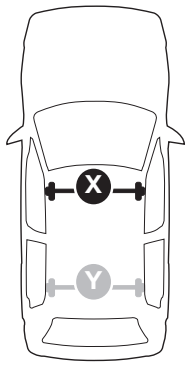

THULE WingBar Evo	THULE WingBar Edge	THULE WingBar	THULE SquareBar Evo	<b>Evo X (scale)</b>	<b>Edge X (scale)</b>
<b>TOYOTA Corolla, 4-dr Sedan, 19-/ *20-</b>				<b>34</b>	<b>K</b>
<b>TOYOTA Corolla Sport, 5-dr Hatchback, 19-</b>				<b>33,5</b>	<b>L</b>
THULE ProBar Evo	THULE SlideBar Evo				<b>X (mm/inch)</b>
<b>TOYOTA Corolla, 4-dr Sedan, 19-/ *20-</b>				<b>991 mm / 39"</b>	
<b>TOYOTA Corolla Sport, 5-dr Hatchback, 19-</b>				<b>986 mm / 38 7/8"</b>	

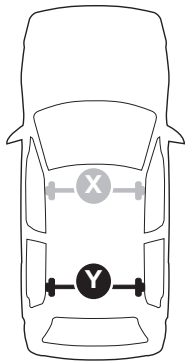

THULE WingBar Evo	THULE WingBar Edge	THULE WingBar	THULE SquareBar Evo	<b>Evo Y (scale)</b>	<b>Edge Y (scale)</b>
<b>TOYOTA Corolla, 4-dr Sedan, 19-/ *20-</b>				<b>29,5</b>	<b>B</b>
<b>TOYOTA Corolla Sport, 5-dr Hatchback, 19-</b>				<b>30,5</b>	<b>R</b>
THULE ProBar Evo	THULE SlideBar Evo				<b>Y (mm/inch)</b>
<b>TOYOTA Corolla, 4-dr Sedan, 19-/ *20-</b>				<b>946 mm / 37 1/4"</b>	
<b>TOYOTA Corolla Sport, 5-dr Hatchback, 19-</b>				<b>956 mm / 37 5/8"</b>	

	<b>W (mm/inch)</b>	<b>Z (mm/inch)</b>
<b>TOYOTA Corolla, 4-dr Sedan, 19-/ *20-</b>	<b>722 mm / 28 3/8"</b>	<b>245 mm / 9 5/8"</b>
<b>TOYOTA Corolla Sport, 5-dr Hatchback, 19-</b>	<b>723 mm / 28 1/2"</b>	<b>245 mm / 9 5/8"</b>

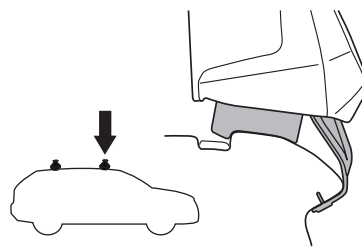
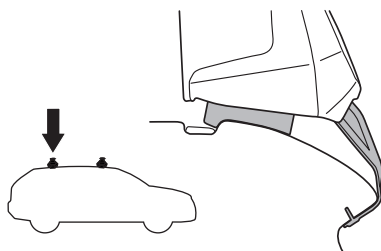
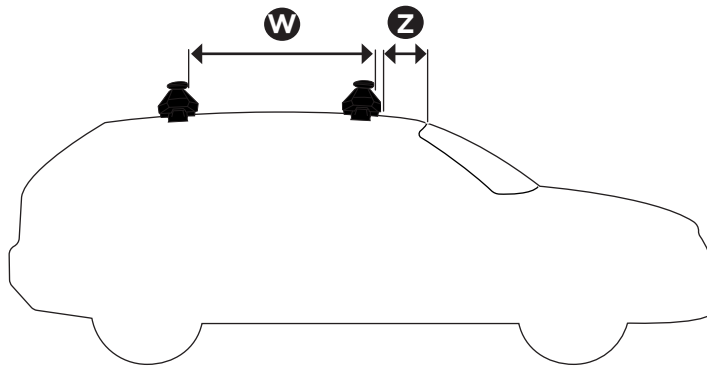
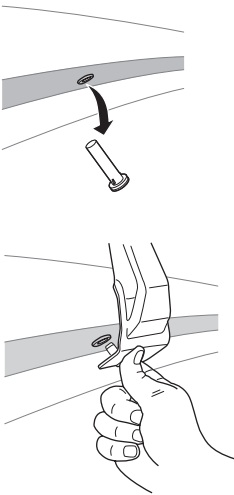

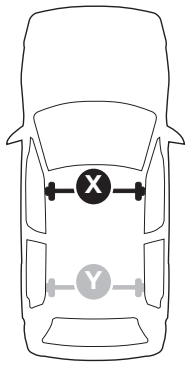

THULE WingBar Evo	THULE WingBar Edge	THULE WingBar	THULE SquareBar Evo	<b>Evo X (scale)</b>	<b>Edge X (scale)</b>
<b>VOLVO S60, 4-dr Sedan, 19-</b>				<b>43</b>	<b>K</b>

THULE ProBar Evo	THULE SlideBar Evo	<b>X (mm/inch)</b>		
<b>VOLVO S60, 4-dr Sedan, 19-</b>		<b>1081 mm / 42 1/2"</b>		

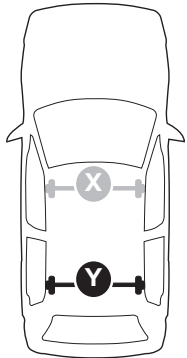

THULE WingBar Evo	THULE WingBar Edge	THULE WingBar	THULE SquareBar Evo	<b>Evo Y (scale)</b>	<b>Edge Y (scale)</b>
<b>VOLVO S60, 4-dr Sedan, 19-</b>				<b>39,5</b>	<b>R</b>

THULE ProBar Evo	THULE SlideBar Evo	<b>Y (mm/inch)</b>		
<b>VOLVO S60, 4-dr Sedan, 19-</b>		<b>1046 mm / 41 1/8"</b>		

	<b>W (mm/inch)</b>	<b>Z (mm/inch)</b>
<b>VOLVO S60, 4-dr Sedan, 19-</b>	<b>705 mm / 27 3/4"</b>	<b>200 mm / 7 7/8"</b>

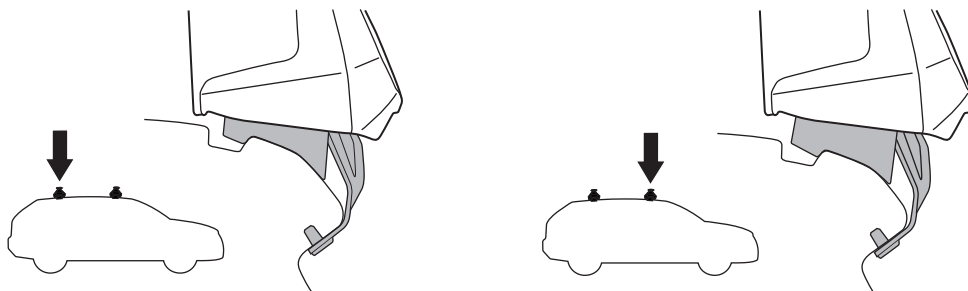
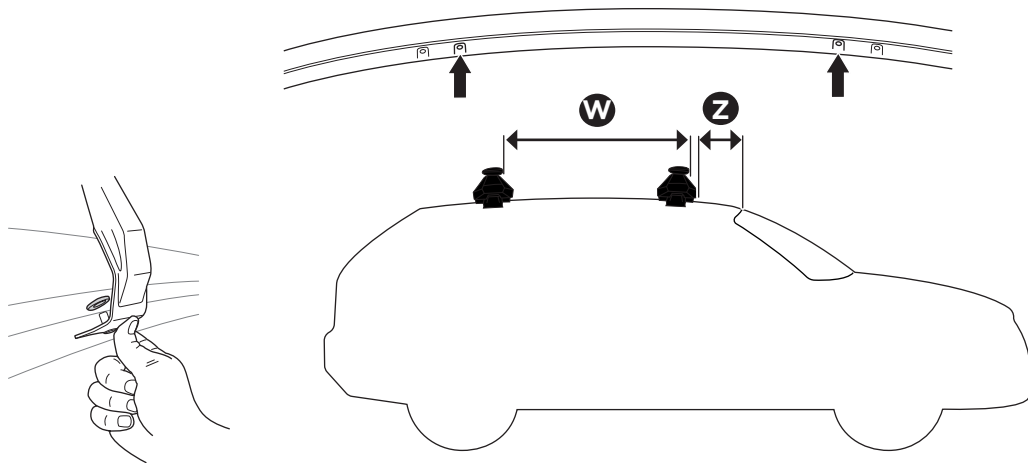

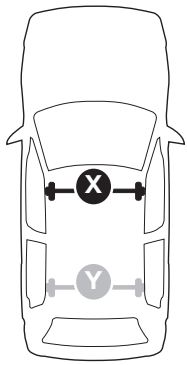

THULE WingBar Evo	THULE WingBar Edge	THULE WingBar	THULE SquareBar Evo	<b>Evo X (scale)</b>	<b>Edge X (scale)</b>
<b>LAND ROVER Discovery Sport, 5-dr SUV, 15-</b>				<b>49</b>	<b>Q</b>
THULE ProBar Evo	THULE SlideBar Evo				<b>X (mm/inch)</b>
<b>LAND ROVER Discovery Sport, 5-dr SUV, 15-</b>				<b>1141 mm / 44 7/8"</b>	

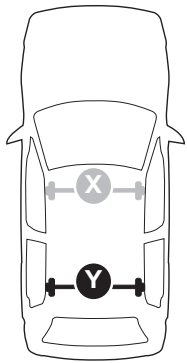

THULE WingBar Evo	THULE WingBar Edge	THULE WingBar	THULE SquareBar Evo	<b>Evo Y (scale)</b>	<b>Edge Y (scale)</b>
<b>LAND ROVER Discovery Sport, 5-dr SUV, 15-</b>				<b>47,5</b>	<b>B</b>
THULE ProBar Evo	THULE SlideBar Evo				<b>Y (mm/inch)</b>
<b>LAND ROVER Discovery Sport, 5-dr SUV, 15-</b>				<b>1126 mm / 44 3/8"</b>	

	<b>W (mm/inch)</b>	<b>Z (mm/inch)</b>
<b>LAND ROVER Discovery Sport, 5-dr SUV, 15-</b>	<b>700 mm / 27 1/2"</b>	<b>275 mm / 10 7/8"</b>

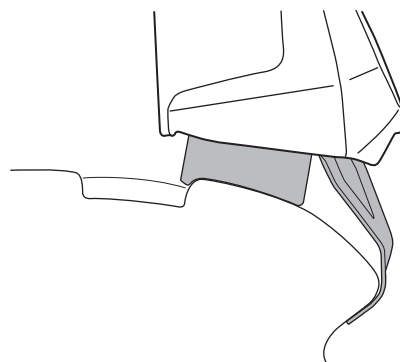
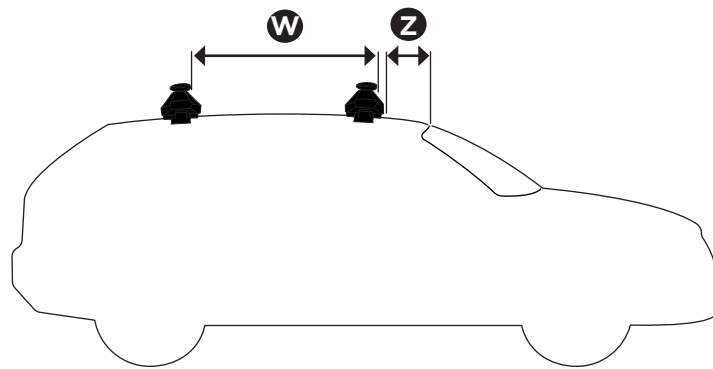

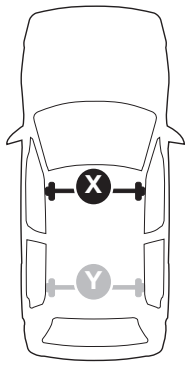

THULE WingBar Evo	THULE WingBar Edge	THULE WingBar	THULE SquareBar Evo	<b>Evo X (scale)</b>	<b>Edge X (scale)</b>
<b>MITSUBITSHI Xpander, 5-dr MPV, 19-</b>				<b>47</b>	<b>C</b>
THULE ProBar Evo	THULE SlideBar Evo				<b>X (mm/inch)</b>
<b>MITSUBITSHI Xpander, 5-dr MPV, 19-</b>				<b>1121 mm / 44 1/8"</b>	

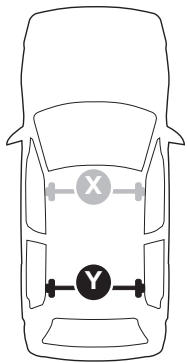

THULE WingBar Evo	THULE WingBar Edge	THULE WingBar	THULE SquareBar Evo	<b>Evo Y (scale)</b>	<b>Edge Y (scale)</b>
<b>MITSUBITSHI Xpander, 5-dr MPV, 19-</b>				<b>44</b>	<b>I</b>
THULE ProBar Evo	THULE SlideBar Evo				<b>Y (mm/inch)</b>
<b>MITSUBITSHI Xpander, 5-dr MPV, 19-</b>				<b>1091 mm / 43"</b>	

	<b>W (mm/inch)</b>	<b>Z (mm/inch)</b>
<b>MITSUBITSHI Xpander, 5-dr MPV, 19-</b>	<b>400 mm / 15 3/4"</b>	<b>750 mm / 29 1/2"</b>

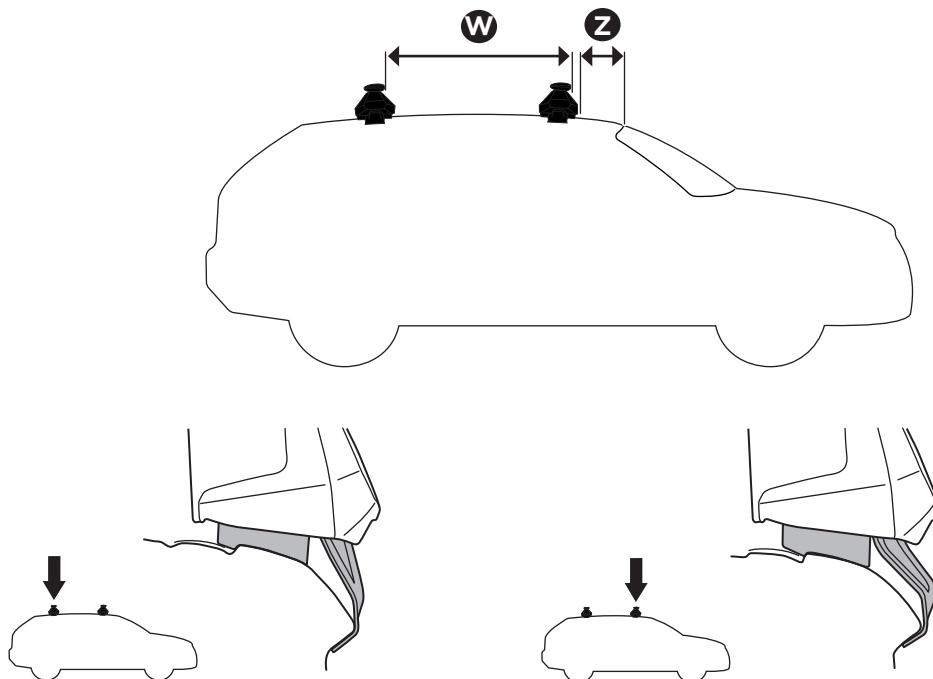

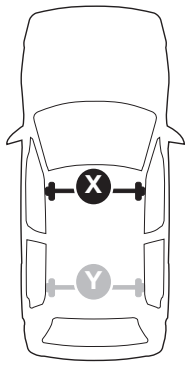

THULE WingBar Evo	THULE WingBar Edge	THULE WingBar	THULE SquareBar Evo	<b>Evo X (scale)</b>	<b>Edge X (scale)</b>
<b>PEUGEOT 3008, 5-dr SUV, 09-16</b>				<b>56</b>	<b>C</b>

THULE ProBar Evo	THULE SlideBar Evo	<b>X (mm/inch)</b>		
<b>PEUGEOT 3008, 5-dr SUV, 09-16</b>		<b>1211 mm / 47 5/8"</b>		

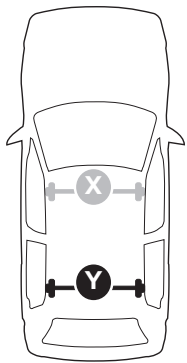

THULE WingBar Evo	THULE WingBar Edge	THULE WingBar	THULE SquareBar Evo	<b>Evo Y (scale)</b>	<b>Edge Y (scale)</b>
<b>PEUGEOT 3008, 5-dr SUV, 09-16</b>				<b>50</b>	<b>O</b>

THULE ProBar Evo	THULE SlideBar Evo	<b>Y (mm/inch)</b>		
<b>PEUGEOT 3008, 5-dr SUV, 09-16</b>		<b>1151 mm / 45 3/8"</b>		

	<b>W (mm/inch)</b>	<b>Z (mm/inch)</b>
<b>PEUGEOT 3008, 5-dr SUV, 09-16</b>	<b>680 mm / 26 3/4"</b>	<b>150 mm / 5 7/8"</b>

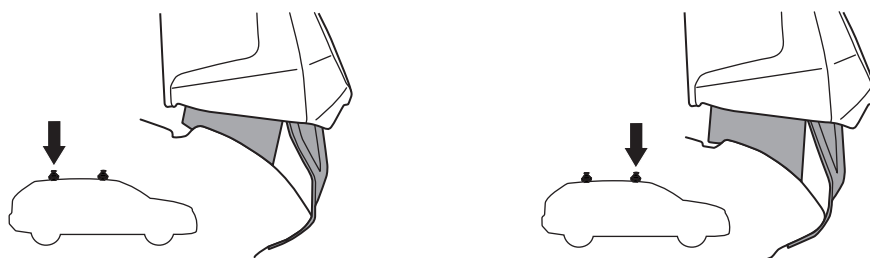
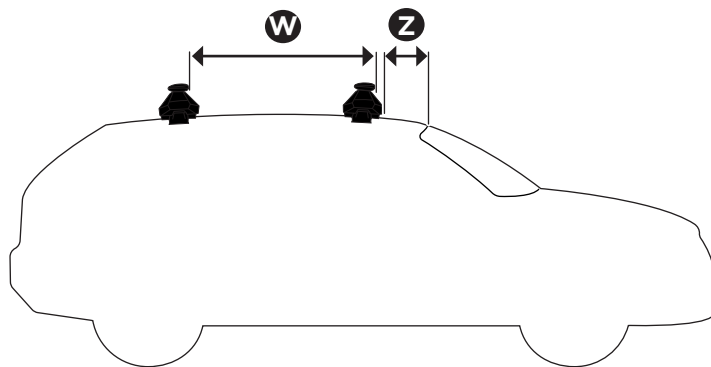

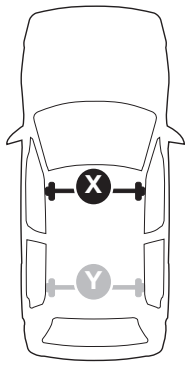

THULE WingBar Evo	THULE WingBar Edge	THULE WingBar	THULE SquareBar Evo	<b>Evo X (scale)</b>	<b>Edge X (scale)</b>
<b>VOLKSWAGEN Arteon Shooting Brake, 5-dr Estate, 21-</b>				<b>46</b>	<b>E</b>

THULE ProBar Evo	THULE SlideBar Evo	<b>X (mm/inch)</b>		
<b>VOLKSWAGEN Arteon Shooting Brake, 5-dr Estate, 21-</b>		<b>1111 mm / 43 3/4"</b>		

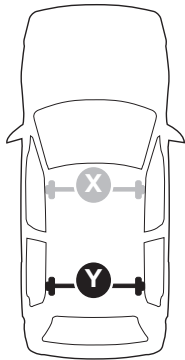

THULE WingBar Evo	THULE WingBar Edge	THULE WingBar	THULE SquareBar Evo	<b>Evo Y (scale)</b>	<b>Edge Y (scale)</b>
<b>VOLKSWAGEN Arteon Shooting Brake, 5-dr Estate, 21-</b>				<b>41</b>	<b>O</b>

THULE ProBar Evo	THULE SlideBar Evo	<b>Y (mm/inch)</b>		
<b>VOLKSWAGEN Arteon Shooting Brake, 5-dr Estate, 21-</b>		<b>1061 mm / 41 3/4"</b>		

	<b>W (mm/inch)</b>	<b>Z (mm/inch)</b>
<b>VOLKSWAGEN Arteon Shooting Brake, 5-dr Estate, 21-</b>	<b>760 mm / 29 7/8"</b>	<b>150 mm / 5 7/8"</b>

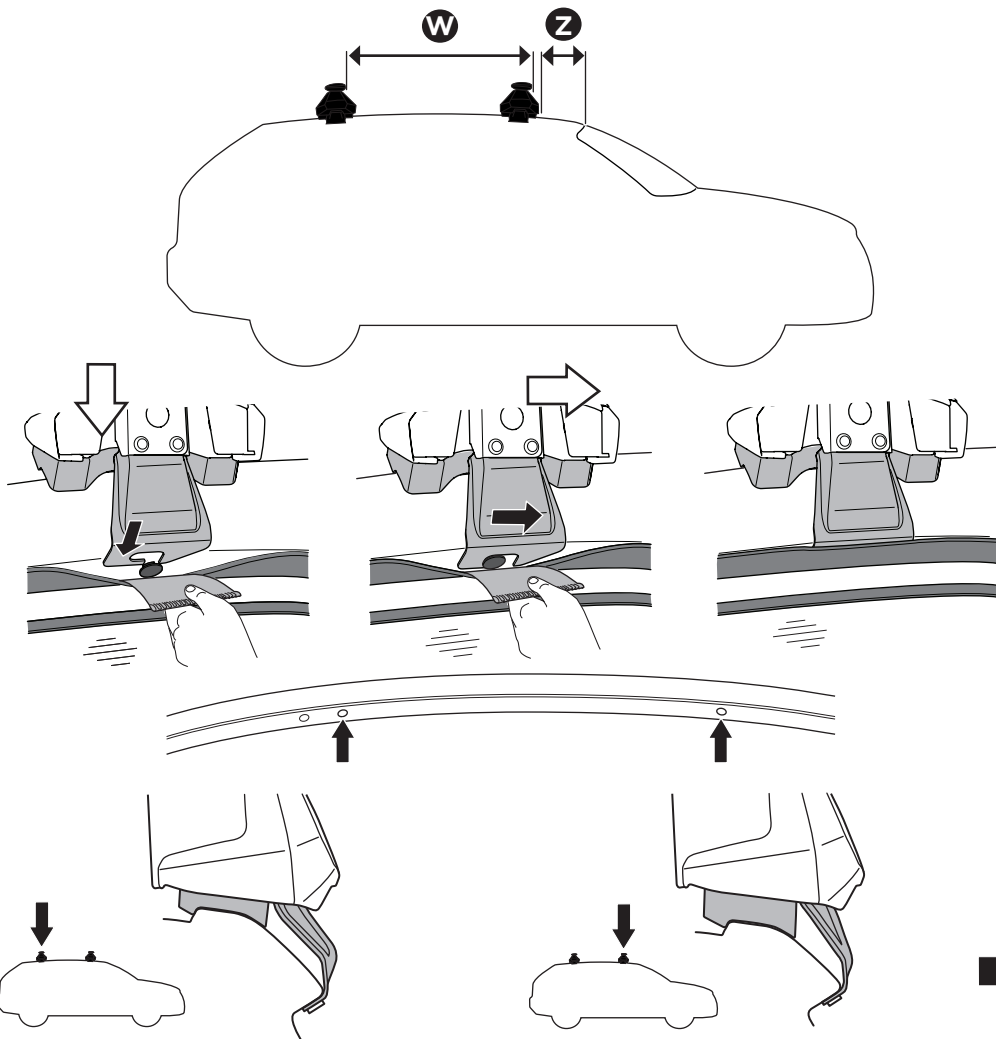

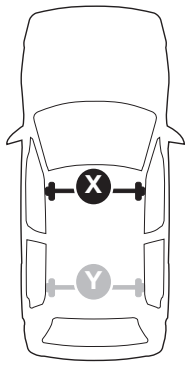

THULE WingBar Evo	THULE WingBar Edge	THULE WingBar	THULE SquareBar Evo	<b>Evo X (scale)</b>	<b>Edge X (scale)</b>
<b>HYUNDAI Kona, 5-dr SUV, 17-*</b>				<b>39</b>	<b>A</b>
THULE ProBar Evo	THULE SlideBar Evo				<b>X (mm/inch)</b>
<b>HYUNDAI Kona, 5-dr SUV, 17-*</b>				<b>1041 mm / 41"</b>	

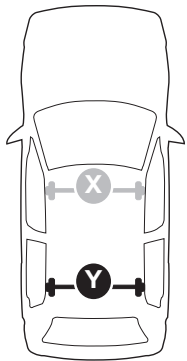

THULE WingBar Evo	THULE WingBar Edge	THULE WingBar	THULE SquareBar Evo	<b>Evo Y (scale)</b>	<b>Edge Y (scale)</b>
<b>HYUNDAI Kona, 5-dr SUV, 17-*</b>				<b>33,5</b>	<b>L</b>
THULE ProBar Evo	THULE SlideBar Evo				<b>Y (mm/inch)</b>
<b>HYUNDAI Kona, 5-dr SUV, 17-*</b>				<b>986 mm / 38 7/8"</b>	

	<b>W (mm/inch)</b>	<b>Z (mm/inch)</b>
<b>HYUNDAI Kona, 5-dr SUV, 17-*</b>	<b>680 mm / 26 3/4"</b>	<b>350 mm / 13 3/4"</b>

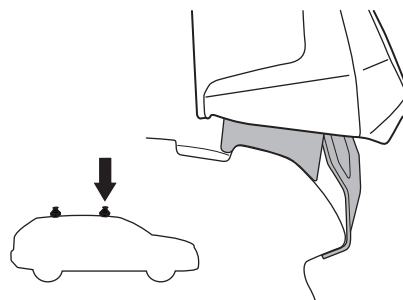
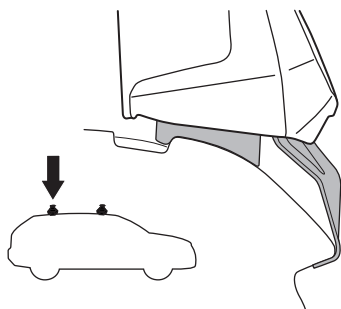
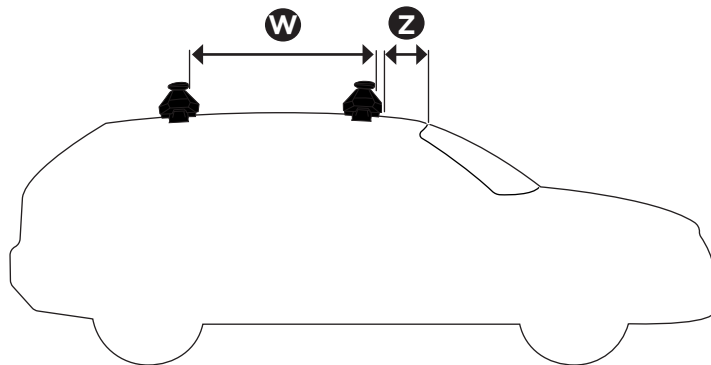

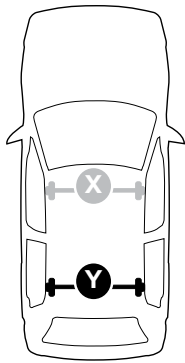
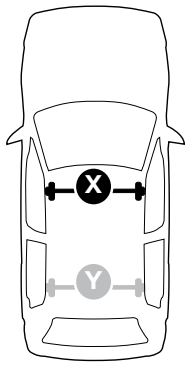

THULE WingBar Evo	THULE WingBar Edge	THULE WingBar	THULE SquareBar Evo	Evo X (scale)	Edge X (scale)
<b>CHEVROLET Spark</b> , 5-dr Hatchback, *15-				33,5	L
<b>OPEL Karl</b> , 5-dr Hatchback, 15-				33,5	L
<b>VAUXHALL Viva</b> , 5-dr Hatchback, 15-				33,5	L

THULE ProBar Evo	THULE SlideBar Evo	X (mm/inch)
<b>CHEVROLET Spark</b> , 5-dr Hatchback, *15-		986 mm / 38 7/8"
<b>OPEL Karl</b> , 5-dr Hatchback, 15-		986 mm / 38 7/8"
<b>VAUXHALL Viva</b> , 5-dr Hatchback, 15-		986 mm / 38 7/8"

THULE WingBar Evo	THULE WingBar Edge	THULE WingBar	THULE SquareBar Evo	Evo Y (scale)	Edge Y (scale)
<b>CHEVROLET Spark</b> , 5-dr Hatchback, *15-				27	G
<b>OPEL Karl</b> , 5-dr Hatchback, 15-				26	I
<b>VAUXHALL Viva</b> , 5-dr Hatchback, 15-				26	I

THULE ProBar Evo	THULE SlideBar Evo	Y (mm/inch)
<b>CHEVROLET Spark</b> , 5-dr Hatchback, *15-		921 mm / 36 1/4"
<b>OPEL Karl</b> , 5-dr Hatchback, 15-		911 mm / 35 7/8"
<b>VAUXHALL Viva</b> , 5-dr Hatchback, 15-		911 mm / 35 7/8"

	W (mm/inch)	Z (mm/inch)
<b>CHEVROLET Spark</b> 5-dr Hatchback, *15-	750 mm / 29 1/2"	200 mm / 7 7/8"
<b>OPEL Karl</b> , 5-dr Hatchback, 15-	700 mm / 27 1/2"	200 mm / 7 7/8"
<b>VAUXHALL Viva</b> , 5-dr Hatchback, 15-	700 mm / 27 1/2"	200 mm / 7 7/8"

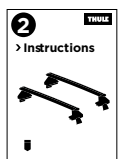
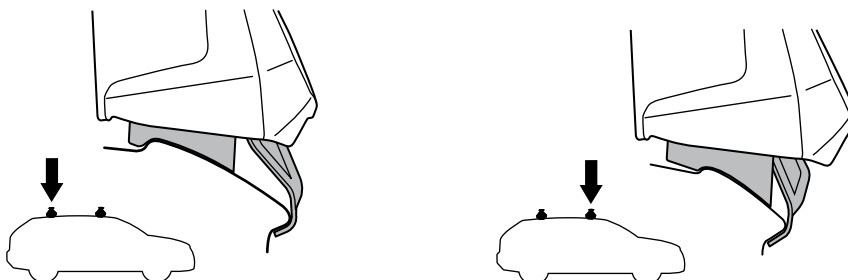
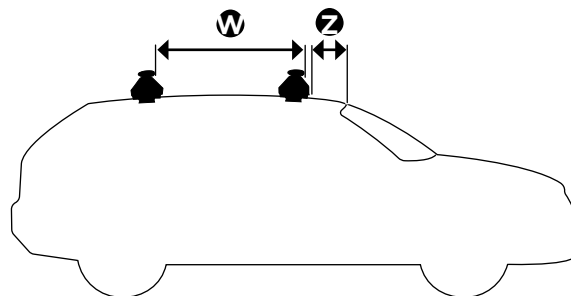

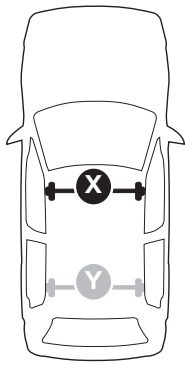

THULE WingBar Evo	THULE WingBar Edge	THULE WingBar	THULE SquareBar Evo	<b>Evo X (scale)</b>	<b>Edge X (scale)</b>
<b>HONDA Civic, 4-dr Sedan, 16-21</b>				<b>38,5</b>	<b>B</b>
THULE ProBar Evo	THULE SlideBar Evo				<b>X (mm/inch)</b>
<b>HONDA Civic, 4-dr Sedan, 16-21</b>				<b>1036 mm / 40 3/4"</b>	

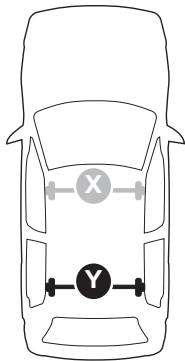

THULE WingBar Evo	THULE WingBar Edge	THULE WingBar	THULE SquareBar Evo	<b>Evo Y (scale)</b>	<b>Edge Y (scale)</b>
<b>HONDA Civic, 4-dr Sedan, 16-21</b>				<b>35</b>	<b>I</b>
THULE ProBar Evo	THULE SlideBar Evo				<b>Y (mm/inch)</b>
<b>HONDA Civic, 4-dr Sedan, 16-21</b>				<b>1001 mm / 39 3/8"</b>	

	<b>W (mm/inch)</b>	<b>Z (mm/inch)</b>
<b>HONDA Civic, 4-dr Sedan, 16-21</b>	<b>750 mm / 29 1/2"</b>	<b>230 mm / 9"</b>

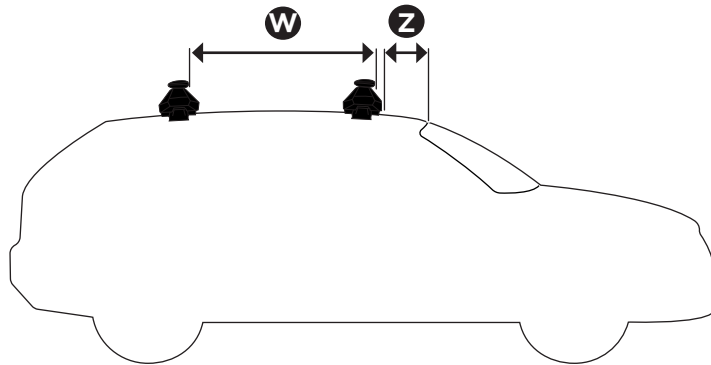

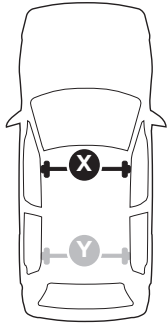

THULE WingBar Evo            THULE WingBar Edge            THULE WingBar            THULE SquareBar Evo	Evo X (scale)	Edge X (scale)
<b>HYUNDAI Avante</b> , 4-dr Sedan, 16-21	42	M
<b>HYUNDAI Elantra</b> , 4-dr Sedan, 16-21 / *17-20	42	M
<b>KIA Cerato</b> , 4-dr Sedan, 13-18	42	M
<b>KIA Forte</b> , 4-dr Sedan, 13-18	42	M
<b>KIA K3</b> , 4-dr Sedan, 13-18	42	M

THULE ProBar Evo            THULE SlideBar Evo	X (mm/inch)
<b>HYUNDAI Avante</b> , 4-dr Sedan, 16-21	1071 mm / 42 1/8"
<b>HYUNDAI Elantra</b> , 4-dr Sedan, 16-21 / *17-20	1071 mm / 42 1/8"
<b>KIA Cerato</b> , 4-dr Sedan, 13-18	1071 mm / 42 1/8"
<b>KIA Forte</b> , 4-dr Sedan, 13-18	1071 mm / 42 1/8"
<b>KIA K3</b> , 4-dr Sedan, 13-18	1071 mm / 42 1/8"

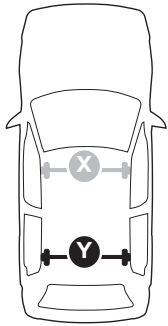





THULE WingBar Evo            THULE WingBar Edge            THULE WingBar            THULE SquareBar Evo	Evo Y (scale)	Edge Y (scale)
<b>HYUNDAI Avante</b> , 4-dr Sedan, 16-21	41,5	N
<b>HYUNDAI Elantra</b> , 4-dr Sedan, 16-21 / *17-20	41,5	N
<b>KIA Cerato</b> , 4-dr Sedan, 13-18	40,5	P
<b>KIA Forte</b> , 4-dr Sedan, 13-18	40,5	P
<b>KIA K3</b> , 4-dr Sedan, 13-18	40,5	P

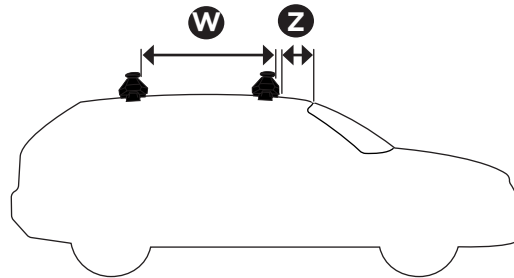
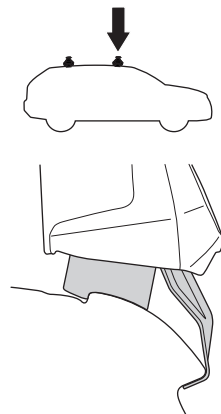
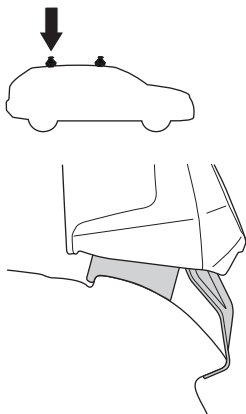

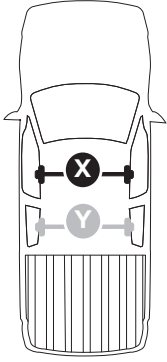
THULE ProBar Evo            THULE SlideBar Evo	Y (mm/inch)
<b>HYUNDAI Avante</b> , 4-dr Sedan, 16-21	1066 mm / 42 "
<b>HYUNDAI Elantra</b> , 4-dr Sedan, 16-21 / *17-20	1066 mm / 42 "
<b>KIA Cerato</b> , 4-dr Sedan, 13-18	1056 mm / 41 5/8"
<b>KIA Forte</b> , 4-dr Sedan, 13-18	1056 mm / 41 5/8"
<b>KIA K3</b> , 4-dr Sedan, 13-18	1056 mm / 41 5/8"

	W (mm/inch)	Z (mm/inch)
<b>HYUNDAI Avante</b> , 4-dr Sedan, 16-21	675 mm / 26 5/8"	250 mm / 9 7/8"
<b>HYUNDAI Elantra</b> , 4-dr Sedan, 16-21 / *17-20	675 mm / 26 5/8"	250 mm / 9 7/8"
<b>KIA Cerato</b> , 4-dr Sedan, 13-18	675 mm / 26 5/8"	250 mm / 9 7/8"
<b>KIA Forte</b> , 4-dr Sedan, 13-18	675 mm / 26 5/8"	250 mm / 9 7/8"
<b>KIA K3</b> , 4-dr Sedan, 13-18	675 mm / 26 5/8"	250 mm / 9 7/8"









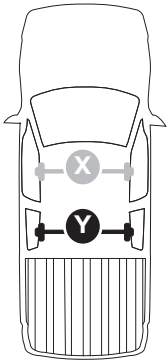

 THULE WingBar Evo  THULE WingBar Edge  THULE WingBar  THULE SquareBar Evo	Evo X (scale)	Edge X (scale)
<b>FORD Ranger (T6), 4-dr Double Cab, 11-22</b>	47	C
<b>FORD Ranger (T6), 4-dr Super Cab, 11-22</b>	47	C
<b>FORD Ranger Raptor (T6), 4-dr Double Cab, 20-22</b>	47	C
<b>MAZDA BT-50, 4-dr Double Cab Cab, 12-</b>	47	C
<b>MAZDA BT-50, 2-dr Single Cab Cab, 12-</b>	47	C

 THULE ProBar Evo  THULE SlideBar Evo	X (mm/inch)
<b>FORD Ranger (T6), 4-dr Double Cab, 11-22</b>	1121 mm / 44 1/8"
<b>FORD Ranger (T6), 4-dr Super Cab, 11-22</b>	1121 mm / 44 1/8"
<b>FORD Ranger Raptor (T6), 4-dr Double Cab, 20-22</b>	1121 mm / 44 1/8"
<b>MAZDA BT-50, 4-dr Double Cab Cab, 12-</b>	1121 mm / 44 1/8"
<b>MAZDA BT-50, 2-dr Single Cab Cab, 12-</b>	1121 mm / 44 1/8"



 THULE WingBar Evo  THULE WingBar Edge  THULE WingBar  THULE SquareBar Evo	Evo Y (scale)	Edge Y (scale)
<b>FORD Ranger (T6), 4-dr Double Cab, 11-22</b>	45	G
<b>FORD Ranger (T6), 4-dr Super Cab, 11-22</b>	44,5	H
<b>FORD Ranger Raptor (T6), 4-dr Double Cab, 20-22</b>	45	G
<b>MAZDA BT-50, 4-dr Double Cab, 12-</b>	44,5	H
<b>MAZDA BT-50, 2-dr Single Cab, 12-</b>	-	-

 THULE ProBar Evo  THULE SlideBar Evo	Y (mm/inch)
<b>FORD Ranger (T6), 4-dr Double Cab, 11-22</b>	1101 mm / 43 3/8"
<b>FORD Ranger (T6), 4-dr Super Cab, 11-22</b>	1096 mm / 43 1/8"
<b>FORD Ranger Raptor (T6), 4-dr Double Cab, 20-22</b>	1101 mm / 43 3/8"
<b>MAZDA BT-50, 4-dr Double Cab, 12-</b>	1096 mm / 43 1/8"
<b>MAZDA BT-50, 2-dr Single Cab, 12-</b>	-

	W (mm/inch)	Z (mm/inch)
<b>FORD Ranger (T6), 4-dr Double Cab, 11-22</b>	700 mm / 27 1/2"	235 mm / 9 1/4"
<b>FORD Ranger (T6), 4-dr Super Cab, 11-22</b>	600 mm / 23 5/8"	185 mm / 7 1/4"
<b>FORD Ranger Raptor (T6), 4-dr Double Cab, 20-22</b>	700 mm / 27 1/2"	235 mm / 9 1/4"
<b>MAZDA BT-50, 4-dr Double Cab, 12-</b>	600 mm / 23 5/8"	185 mm / 7 1/4"
<b>MAZDA BT-50, 2-dr Single Cab, 12-</b>	-	185 mm / 7 1/4"

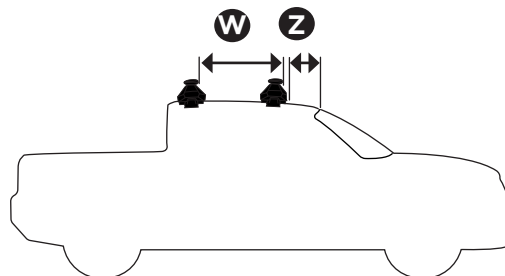
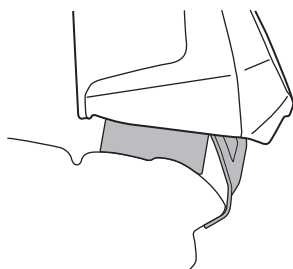

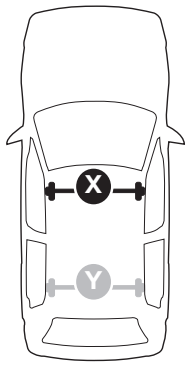

THULE WingBar Evo	THULE WingBar Edge	THULE WingBar	THULE SquareBar Evo	<b>Evo X (scale)</b>	<b>Edge X (scale)</b>
<b>HYUNDAI i10, 5-dr Hatchback, 20-</b>				<b>7</b>	<b>K</b>
THULE ProBar Evo	THULE SlideBar Evo				<b>X (mm/inch)</b>
<b>HYUNDAI i10, 5-dr Hatchback, 20-</b>				<b>1021 mm / 40 1/4"</b>	

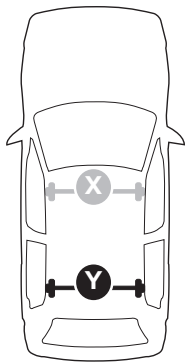

THULE WingBar Evo	THULE WingBar Edge	THULE WingBar	THULE SquareBar Evo	<b>Evo Y (scale)</b>	<b>Edge Y (scale)</b>
<b>HYUNDAI i10, 5-dr Hatchback, 20-</b>				<b>33,5</b>	<b>L</b>
THULE ProBar Evo	THULE SlideBar Evo				<b>Y (mm/inch)</b>
<b>HYUNDAI i10, 5-dr Hatchback, 20-</b>				<b>986 mm / 38 7/8"</b>	

	<b>W (mm/inch)</b>	<b>Z (mm/inch)</b>
<b>HYUNDAI i10, 5-dr Hatchback, 20-</b>	<b>700 mm / 27 1/2"</b>	<b>240 mm / 9 1/2"</b>

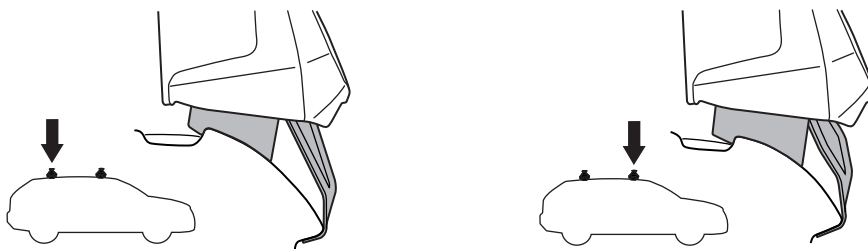
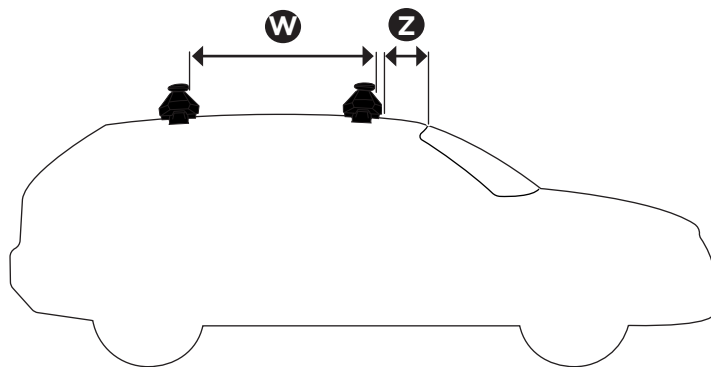

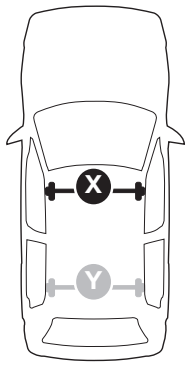

THULE WingBar Evo	THULE WingBar Edge	THULE WingBar	THULE SquareBar Evo	<b>Evo X (scale)</b>	<b>Edge X (scale)</b>
<b>FORD Escape, 5-dr SUV, 20-</b>				54,5	F
THULE ProBar Evo	THULE SlideBar Evo				<b>X (mm/inch)</b>
<b>FORD Escape, 5-dr SUV, 20-</b>				1196 mm / 47 1/8"	

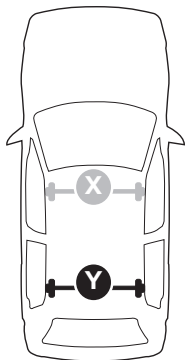

THULE WingBar Evo	THULE WingBar Edge	THULE WingBar	THULE SquareBar Evo	<b>Evo Y (scale)</b>	<b>Edge Y (scale)</b>
<b>FORD Escape, 5-dr SUV, 20-</b>				48	A
THULE ProBar Evo	THULE SlideBar Evo				<b>Y (mm/inch)</b>
<b>FORD Escape, 5-dr SUV, 20-</b>				1131 mm / 44 1/2"	

	<b>W (mm/inch)</b>	<b>Z (mm/inch)</b>
<b>FORD Escape, 5-dr SUV, 20-</b>	680 mm / 26 3/4"	290 mm / 11 3/8"

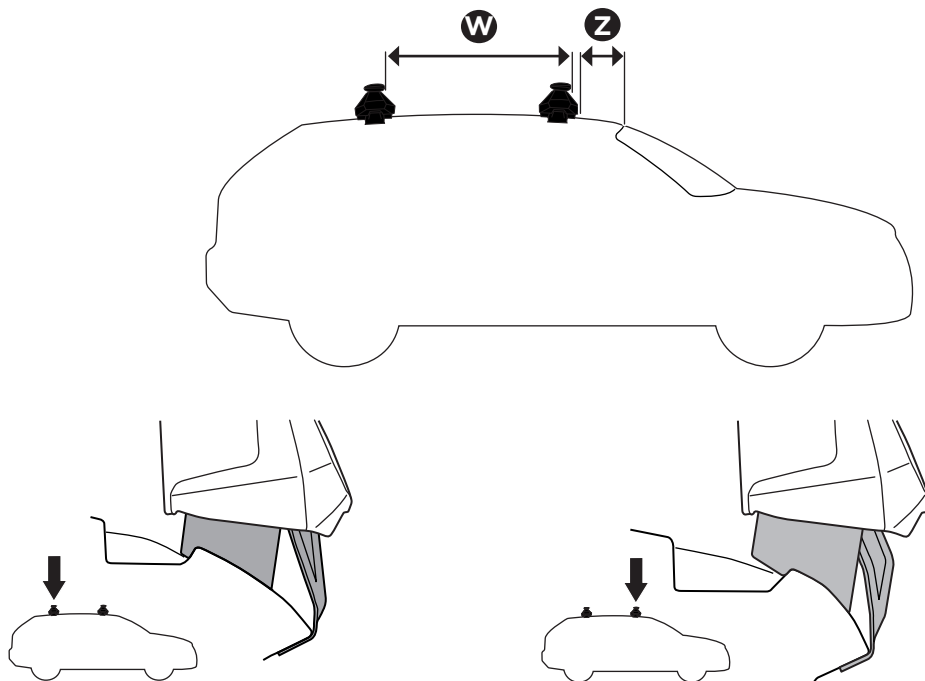

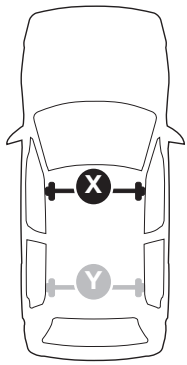

THULE WingBar Evo	THULE WingBar Edge	THULE WingBar	THULE SquareBar Evo	<b>Evo X (scale)</b>	<b>Edge X (scale)</b>
<b>AUDI e-tron Sportback, 5-dr SUV, 20-</b>				<b>47,5</b>	<b>B</b>
THULE ProBar Evo	THULE SlideBar Evo				<b>X (mm/inch)</b>
<b>AUDI e-tron Sportback, 5-dr SUV, 20-</b>				<b>1126 mm / 44 3/8"</b>	

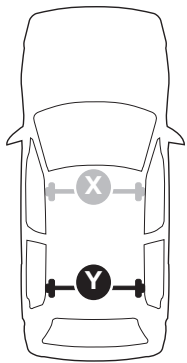

THULE WingBar Evo	THULE WingBar Edge	THULE WingBar	THULE SquareBar Evo	<b>Evo Y (scale)</b>	<b>Edge Y (scale)</b>
<b>AUDI e-tron Sportback, 5-dr SUV, 20-</b>				<b>42,5</b>	<b>L</b>
THULE ProBar Evo	THULE SlideBar Evo				<b>Y (mm/inch)</b>
<b>AUDI e-tron Sportback, 5-dr SUV, 20-</b>				<b>1076 mm / 42 3/8"</b>	

	<b>W (mm/inch)</b>	<b>Z (mm/inch)</b>
<b>AUDI e-tron Sportback, 5-dr SUV, 20-</b>	<b>720 mm / 28 3/8"</b>	<b>250 mm / 9 7/8"</b>

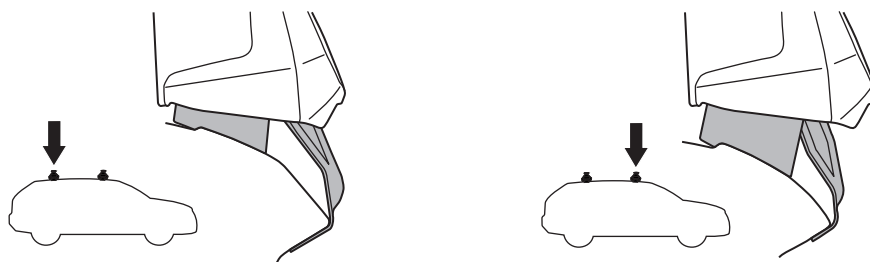
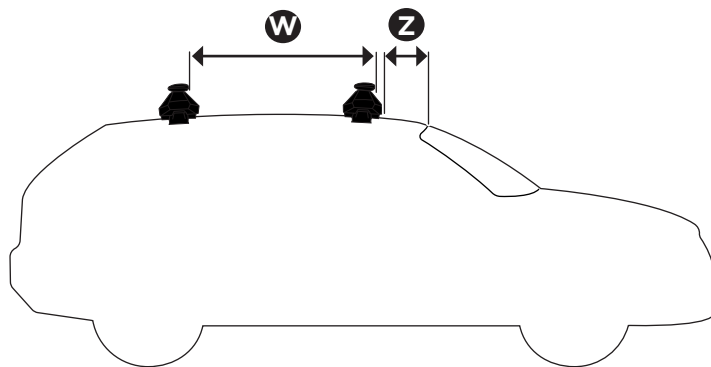

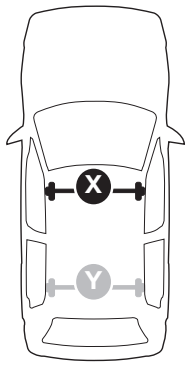

THULE WingBar Evo	THULE WingBar Edge	THULE WingBar	THULE SquareBar Evo	<b>Evo X (scale)</b>	<b>Edge X (scale)</b>
<b>SEAT León, 5-dr Hatchback, 20-</b>				<b>43</b>	<b>K</b>
THULE ProBar Evo	THULE SlideBar Evo				<b>X (mm/inch)</b>
<b>SEAT León, 5-dr Hatchback, 20-</b>				<b>1081 mm / 42 1/2"</b>	

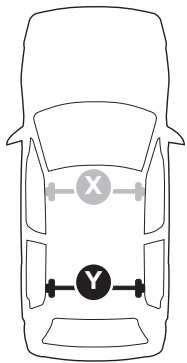

THULE WingBar Evo	THULE WingBar Edge	THULE WingBar	THULE SquareBar Evo	<b>Evo Y (scale)</b>	<b>Edge Y (scale)</b>
<b>SEAT León, 5-dr Hatchback, 20-</b>				<b>32,5</b>	<b>N</b>
THULE ProBar Evo	THULE SlideBar Evo				<b>Y (mm/inch)</b>
<b>SEAT León, 5-dr Hatchback, 20-</b>				<b>976 mm / 38 3/8"</b>	

	<b>W (mm/inch)</b>	<b>Z (mm/inch)</b>
<b>SEAT León, 5-dr Hatchback, 20-</b>	<b>752 mm / 29 5/8"</b>	<b>215 mm / 8 1/2"</b>

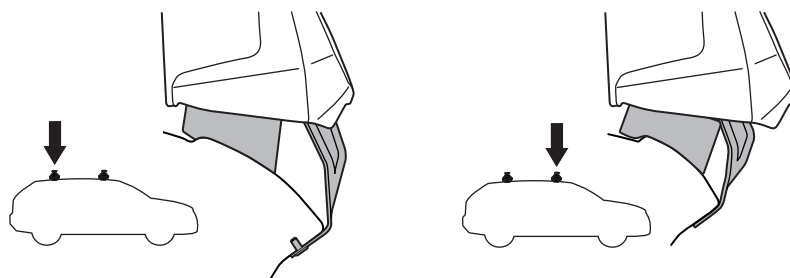
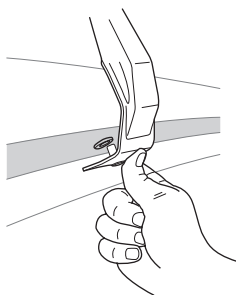
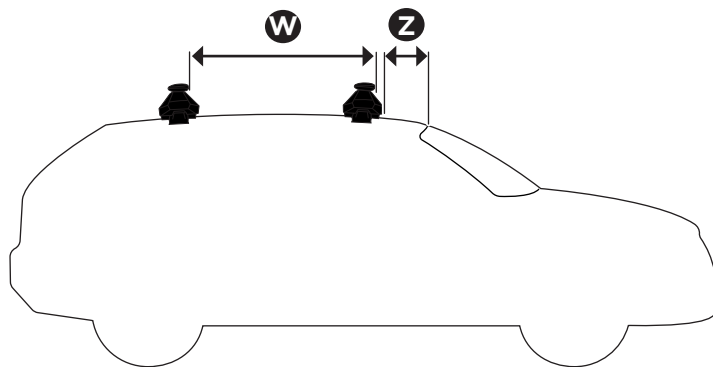

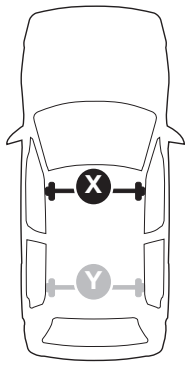

THULE WingBar Evo	THULE WingBar Edge	THULE WingBar	THULE SquareBar Evo	<b>Evo X (scale)</b>	<b>Edge X (scale)</b>
<b>FORD Grand C-Max, 5-dr MPV, 10-19</b>				<b>37</b>	<b>E</b>
THULE ProBar Evo	THULE SlideBar Evo				<b>X (mm/inch)</b>
<b>FORD Grand C-Max, 5-dr MPV, 10-19</b>				<b>1021 mm / 40 1/4"</b>	

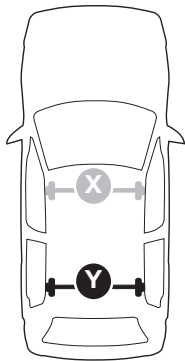



THULE WingBar Evo	THULE WingBar Edge	THULE WingBar	THULE SquareBar Evo	<b>Evo Y (scale)</b>	<b>Edge Y (scale)</b>
<b>FORD Grand C-Max, 5-dr MPV, 10-19</b>				<b>36</b>	<b>G</b>
THULE ProBar Evo	THULE SlideBar Evo				<b>Y (mm/inch)</b>
<b>FORD Grand C-Max, 5-dr MPV, 10-19</b>				<b>1011 mm / 39 3/4"</b>	

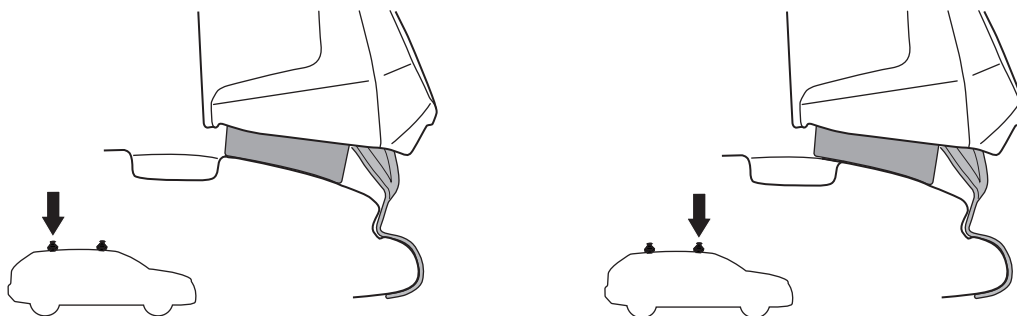
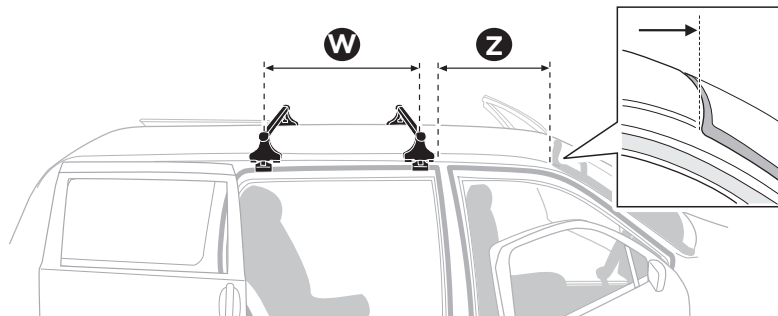

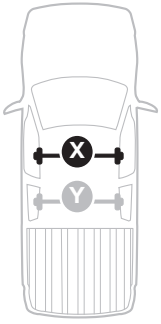
	<b>W (mm/inch)</b>	<b>Z (mm/inch)</b>
<b>FORD Grand C-Max, 5-dr MPV, 10-19</b>	<b>700 mm / 27 1/2"</b>	<b>680 mm / 26 3/4"</b>



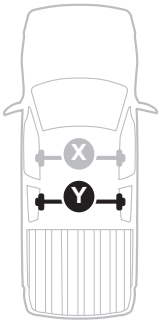

 THULE ProBar Evo  THULE SlideBar Evo	X (mm/inch)
<b>FORD F-150</b> , 4-dr Pickup, 21-	1321 mm / 52"
<b>FORD F-150 Lightning</b> , 4-dr Pickup, 22-	1321 mm / 52"
<b>FORD F-150</b> , 4-dr Pickup, 15-20	1321 mm / 52"
<b>FORD Super Duty</b> , 4-dr Pickup, 17-	1326 mm / 52 1/4"



 THULE ProBar Evo  THULE SlideBar Evo	Y (mm/inch)
<b>FORD F-150</b> , 4-dr Pickup, 21-	1321 mm / 51 3/4"
<b>FORD F-150 Lightning</b> , 4-dr Pickup, 22-	1321 mm / 51 3/4"
<b>FORD F-150</b> , 4-dr Pickup, 15-20	1316 mm / 51 3/4"
<b>FORD Super Duty</b> , 4-dr Pickup, 17-	1321 mm / 52"

	W (mm/inch)	Z (mm/inch)
<b>FORD F-150</b> , 4-dr Pickup, 21-	700 mm / 27 1/2"	340 mm / 13 3/8"
<b>FORD F-150 Lightning</b> , 4-dr Pickup, 22-	700 mm / 27 1/2"	340 mm / 13 3/8"
<b>FORD F-150</b> , 4-dr Pickup, 15-20	700 mm / 27 1/2"	340 mm / 13 3/8"
<b>FORD Super Duty</b> , 4-dr Pickup, 17-	700 mm / 27 1/2"	340 mm / 13 3/8"

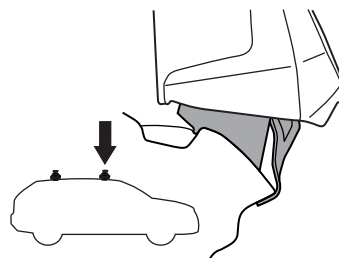
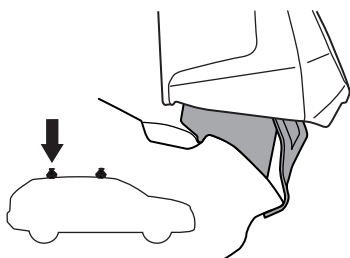
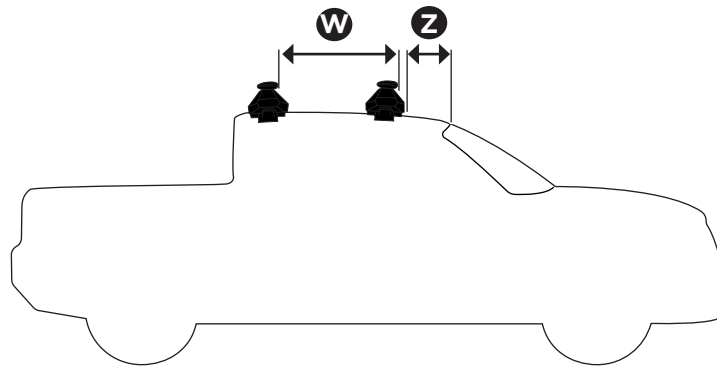

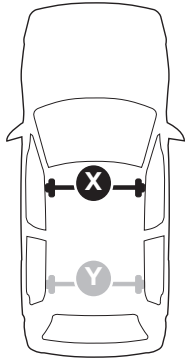

THULE WingBar Evo	THULE WingBar Edge	THULE WingBar	THULE SquareBar Evo	<b>Evo X (scale)</b>	<b>Edge X (scale)</b>
<b>TOYOTA Vitz (XP130), 5-dr Hatchback, 10-20</b>				<b>30,5</b>	<b>R</b>
<b>TOYOTA Yaris (XP130), 5-dr Hatchback, 12-20</b>				<b>30,5</b>	<b>R</b>

THULE ProBar Evo	THULE SlideBar Evo			<b>X (mm/inch)</b>	
<b>TOYOTA Vitz (XP130), 5-dr Hatchback, 10-20</b>				<b>956 mm / 37 5/8"</b>	
<b>TOYOTA Yaris (XP130), 5-dr Hatchback, 12-20</b>				<b>956 mm / 37 5/8"</b>	

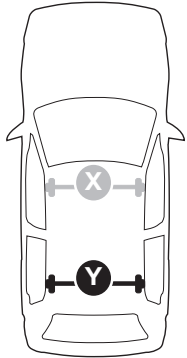

THULE WingBar Evo	THULE WingBar Edge	THULE WingBar	THULE SquareBar Evo	<b>Evo Y (scale)</b>	<b>Edge Y (scale)</b>
<b>TOYOTA Vitz (XP130), 5-dr Hatchback, 10-20</b>				<b>26</b>	<b>I</b>
<b>TOYOTA Yaris (XP130), 5-dr Hatchback, 12-20</b>				<b>26</b>	<b>I</b>

THULE ProBar Evo	THULE SlideBar Evo			<b>Y (mm/inch)</b>	
<b>TOYOTA Vitz (XP130), 5-dr Hatchback, 10-20</b>				<b>911 mm / 35 7/8"</b>	
<b>TOYOTA Yaris (XP130), 5-dr Hatchback, 12-20</b>				<b>911 mm / 35 7/8"</b>	

	<b>W (mm/inch)</b>	<b>Z (mm/inch)</b>
<b>TOYOTA Vitz (XP130), 5-dr Hatchback, 10-20</b>	<b>710 mm / 28"</b>	<b>180 mm / 7 1/8"</b>
<b>TOYOTA Yaris (XP130), 5-dr Hatchback, 12-20</b>	<b>710 mm / 28"</b>	<b>180 mm / 7 1/8"</b>

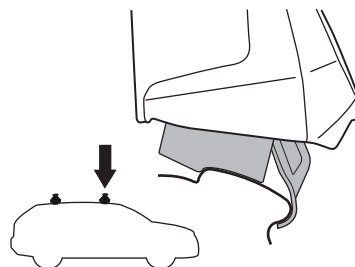
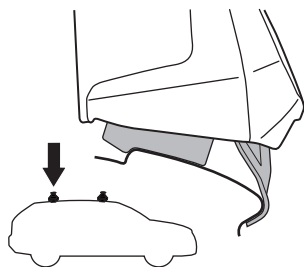
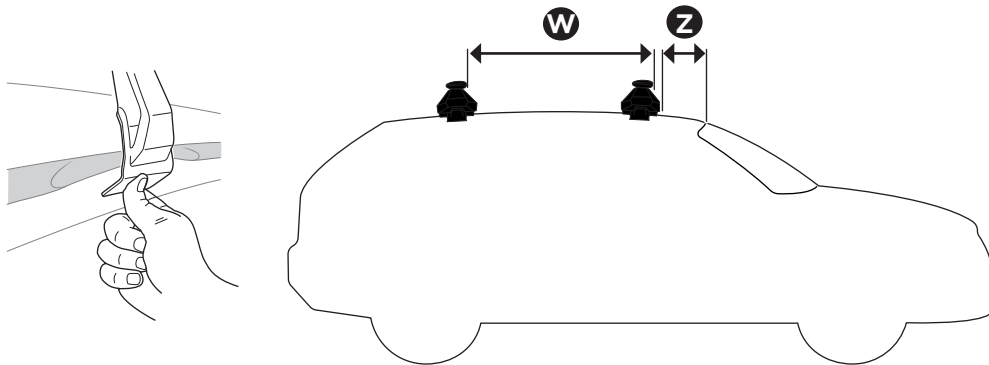

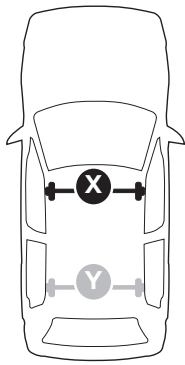

THULE WingBar Evo	THULE WingBar Edge	THULE WingBar	THULE SquareBar Evo	Evo X (scale)	Edge X (scale)
PEUGEOT 3008, 5-dr SUV, 17-				44,5	H
PEUGEOT 5008, 5-dr SUV, 17-				48,5	R

THULE ProBar Evo	THULE SlideBar Evo	X (mm/inch)	
PEUGEOT 3008, 5-dr SUV, 17-		1096 mm / 43 1/8"	
PEUGEOT 5008, 5-dr SUV, 17-		1136 mm / 44 3/4"	

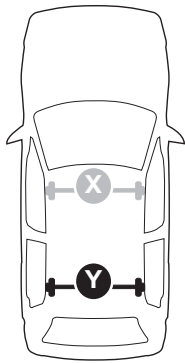

THULE WingBar Evo	THULE WingBar Edge	THULE WingBar	THULE SquareBar Evo	Evo Y (scale)	Edge Y (scale)
PEUGEOT 3008, 5-dr SUV, 17-				41,5	N
PEUGEOT 5008, 5-dr SUV, 17-				44,5	H

THULE ProBar Evo	THULE SlideBar Evo	Y (mm/inch)
PEUGEOT 3008, 5-dr SUV, 17-		1066 mm / 42"
PEUGEOT 5008, 5-dr SUV, 17-		1096 mm / 43 1/8"

	W (mm/inch)	Z (mm/inch)
PEUGEOT 3008, 5-dr SUV, 17-	720 mm / 28 3/8"	259 mm / 10 1/4"
PEUGEOT 5008, 5-dr SUV, 17-	740 mm / 29 1/8"	259 mm / 10 1/4"



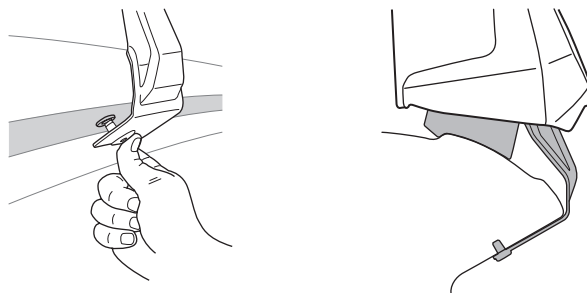
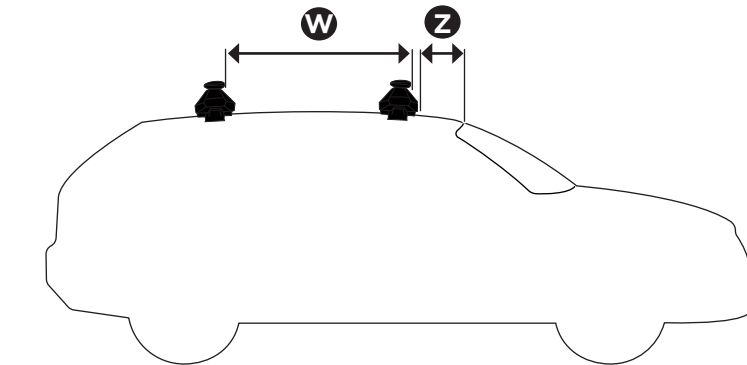

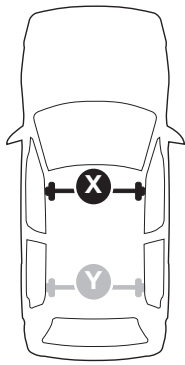
THULE WingBar Evo	THULE WingBar Edge	THULE WingBar	THULE SquareBar Evo	<b>Evo X (scale)</b>	<b>Edge X (scale)</b>
<b>NISSAN Qashqai, 5-dr SUV, 14-21</b>				<b>47</b>	<b>C</b>

THULE ProBar Evo	THULE SlideBar Evo	<b>X (mm/inch)</b>		
<b>NISSAN Qashqai, 5-dr SUV, 14-21</b>		<b>1121 mm / 44 1/8"</b>		

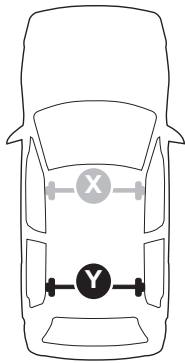

THULE WingBar Evo	THULE WingBar Edge	THULE WingBar	THULE SquareBar Evo	<b>Evo Y (scale)</b>	<b>Edge Y (scale)</b>
<b>NISSAN Qashqai, 5-dr SUV, 14-21</b>				<b>37,5</b>	<b>D</b>

THULE ProBar Evo	THULE SlideBar Evo	<b>Y (mm/inch)</b>		
<b>NISSAN Qashqai, 5-dr SUV, 14-21</b>		<b>1026 mm / 40 3/8"</b>		

	<b>W (mm/inch)</b>	<b>Z (mm/inch)</b>
<b>NISSAN Qashqai, 5-dr SUV, 14-21</b>	<b>775 mm / 30 1/2"</b>	<b>140 mm / 5 1/5"</b>

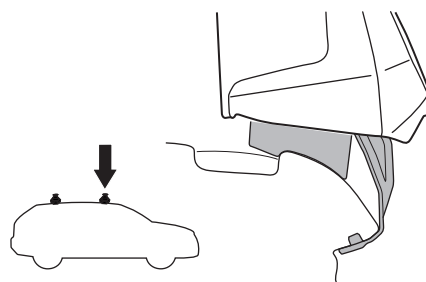
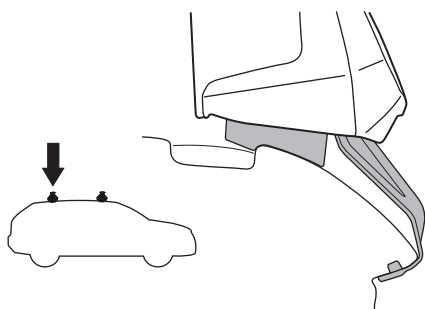
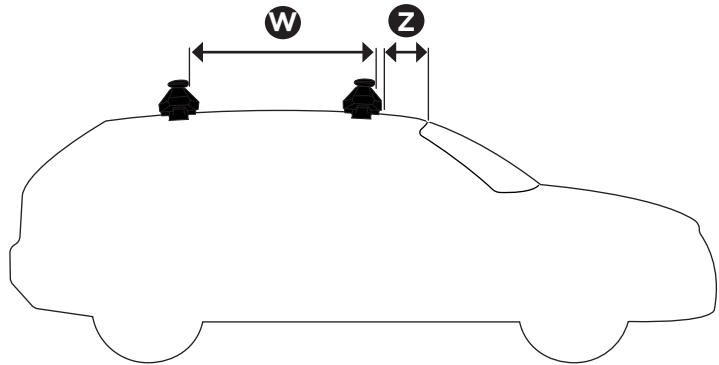
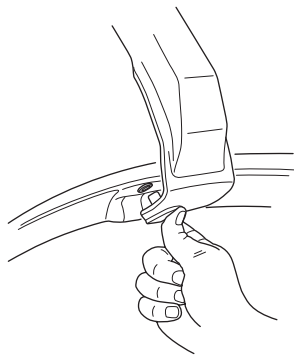

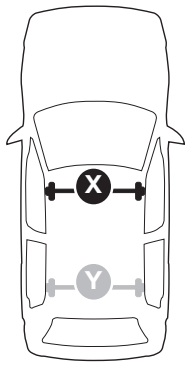

THULE WingBar Evo	THULE WingBar Edge	THULE WingBar	THULE SquareBar Evo	<b>Evo X (scale)</b>	<b>Edge X (scale)</b>
<b>HYUNDAI Tucson, 5-dr SUV, 15-21</b>				<b>45</b>	<b>G</b>
THULE ProBar Evo	THULE SlideBar Evo				<b>X (mm/inch)</b>
<b>HYUNDAI Tucson, 5-dr SUV, 15-21</b>				<b>1101 mm / 43 3/8"</b>	

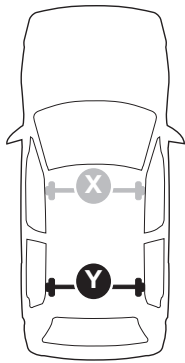

THULE WingBar Evo	THULE WingBar Edge	THULE WingBar	THULE SquareBar Evo	<b>Evo Y (scale)</b>	<b>Edge Y (scale)</b>
<b>HYUNDAI Tucson, 5-dr SUV, 15-21</b>				<b>42</b>	<b>M</b>
THULE ProBar Evo	THULE SlideBar Evo				<b>Y (mm/inch)</b>
<b>HYUNDAI Tucson, 5-dr SUV, 15-21</b>				<b>1071 mm / 42 1/8"</b>	

	<b>W (mm/inch)</b>	<b>Z (mm/inch)</b>
<b>HYUNDAI Tucson, 5-dr SUV, 15-21</b>	<b>700 mm / 27 1/2"</b>	<b>300 mm / 11 3/4"</b>

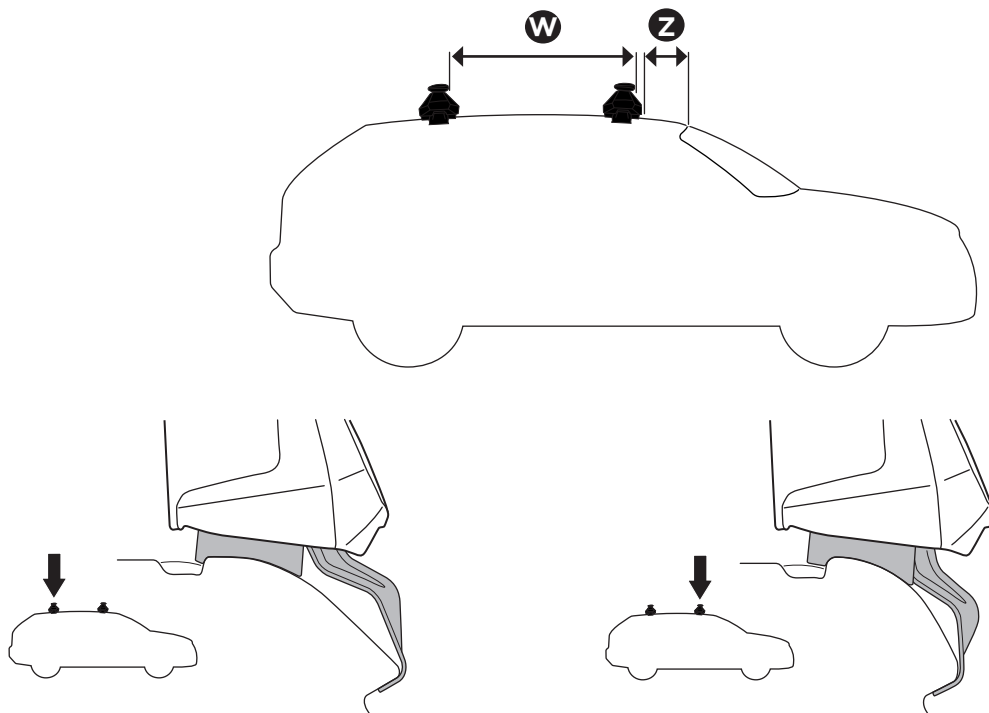

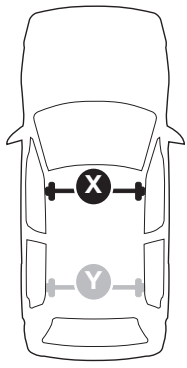

THULE WingBar Evo	THULE WingBar Edge	THULE WingBar	THULE SquareBar Evo	<b>Evo X (scale)</b>	<b>Edge X (scale)</b>
<b>HONDA Civic, 5-dr Hatchback, 17-21 (Without glassroof)</b>				<b>40,5</b>	<b>P</b>
THULE ProBar Evo	THULE SlideBar Evo				<b>X (mm/inch)</b>
<b>HONDA Civic, 5-dr Hatchback, 17-21 (Without glassroof)</b>				<b>1056 mm / 41 5/8"</b>	

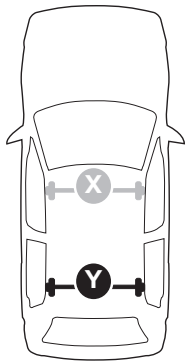

THULE WingBar Evo	THULE WingBar Edge	THULE WingBar	THULE SquareBar Evo	<b>Evo Y (scale)</b>	<b>Edge Y (scale)</b>
<b>HONDA Civic, 5-dr Hatchback, 17-21 (Without glassroof)</b>				<b>36,5</b>	<b>F</b>
THULE ProBar Evo	THULE SlideBar Evo				<b>Y (mm/inch)</b>
<b>HONDA Civic, 5-dr Hatchback, 17-21 (Without glassroof)</b>				<b>1016 mm / 40"</b>	

	<b>W (mm/inch)</b>	<b>Z (mm/inch)</b>
<b>HONDA Civic, 5-dr Hatchback, 17-21 (Without glassroof)</b>	<b>680 mm / 26 3/4"</b>	<b>200 mm / 7 7/8"</b>

